



Advantage Plank  
Arctic Drift

**XRP**® WaterProof Floors  
The Install Everywhere Floor™



**FINAL VINYL**  
WATERPROOF FLOORS

Loose Lay Plank  
Timber Wood



8WR  
Sheer Mist

**DUXYE**  
WATER AND SCRATCH RESILIENT FLOORING



**LUXMAX**  
LUXURY CARPET  
WITH MAXIMUM PROTECTION

Wingate  
Chateau

 **SOUTHWIND**  
FLOORS FOR LIFE

# WPC FLOORING

Our WPC floors are 100% waterproof, which means there is no swelling of planks or damages as a result of exposure to spills and other forms of moisture. Through our technically advanced construction, our engineered core backing combines plastic composites and foaming agents to form a bond of strength and stability. Topped with a virgin vinyl top layer for superior softness and quietness under foot that the entire family can enjoy. Matched with an industry-leading wear layer and two coats of urethane finish, these floors are built to take the punishment of an active household or business.

Each product sports an attached underlayment and easy click lock installation method that is DIY friendly and can be installed as a floating floor over virtually any subfloor. Lastly, cleaning and maintenance are a snap, requiring only regular sweeping and the occasional spot cleaning or mopping.

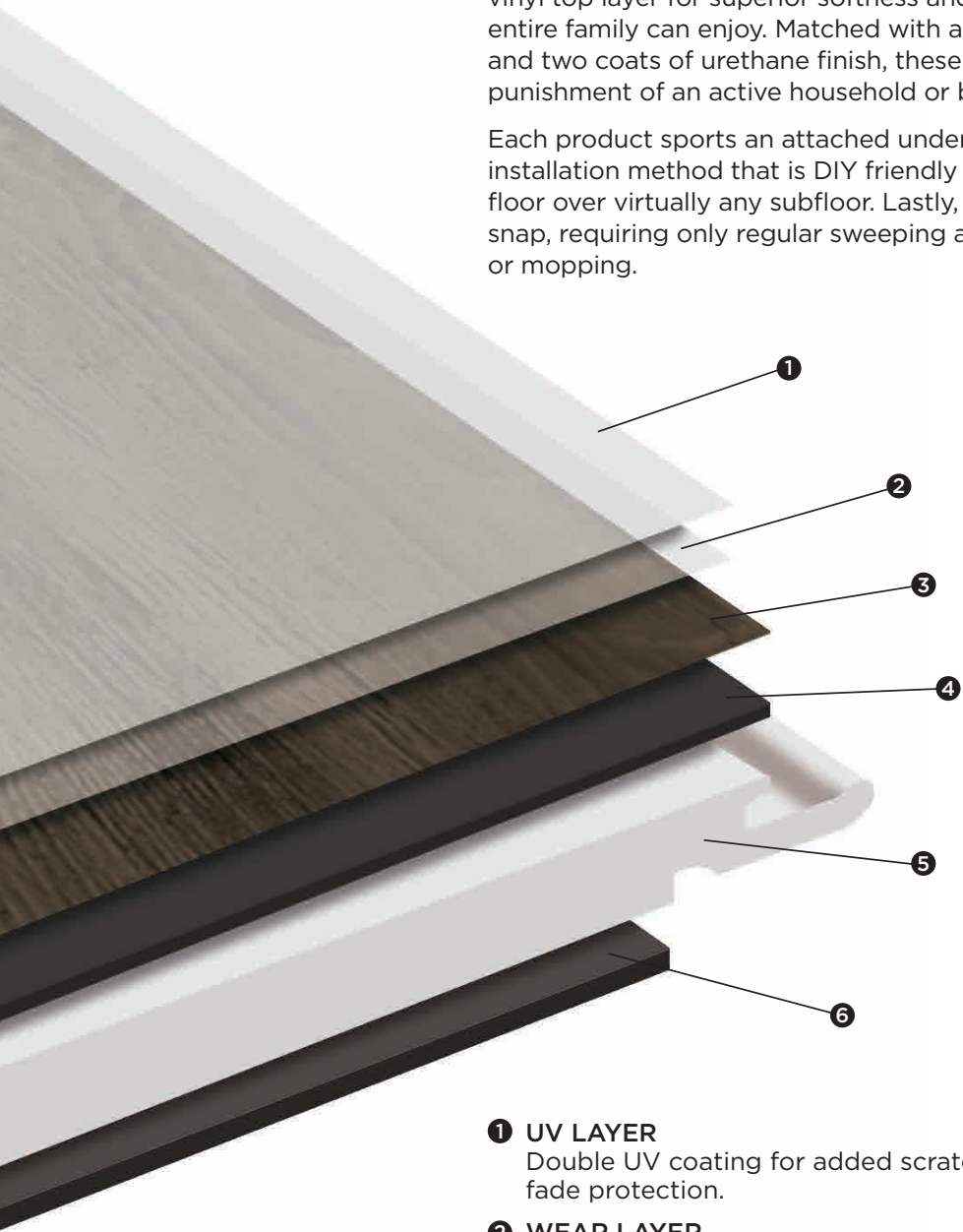

- 1 UV LAYER**  
Double UV coating for added scratch and fade protection.
- 2 WEAR LAYER**  
Protective Urethane Layer for stain and scratch resistance.
- 3 DÉCOR FILM**  
Realistic wood décor. Dent resistant.
- 4 VINYL LAYER**  
100% Waterproof.
- 5 COMPOSITE CORE**  
100% Waterproof.
- 6 UNDERLAYMENT**  
IXPE Closed Cell cushion for advanced sound absorption. Impervious to water. Hides subfloor imperfections.



## AUTHENTIC MIX - WPC

**AUTHENTIC MIX** is the ultimate waterproof flooring that comes with mixed widths and mixed lengths, packaged together in the same box. Still featuring a high density core, sound deadening pad and commercial grade wear layer, *Authentic Mix* offers you the high end varied look of hardwood flooring with the Lifetime Warranty and waterproof peace of mind.

### SPECIFICATIONS

- 8mm thick with a 20 mil wear layer with double UV coating
- Mixed Widths: 4.88" / 6.85" / 8.86"
- Mixed Lengths: 19.45" / 39.29" / 59.05"
- 1.5mm vinyl top layer
- 5mm composite core
- 1.5mm IXPE underlayment attached
- EIR detailed texture & graining
- V groove painted bevel
- Uniclic locking system
- Sq Ft per carton: 16.87
- Sq Ft per pallet: 1,265.25



Trim and molding options available. See your Southwind Professional Dealer for details.

[SouthwindFloors.com](http://SouthwindFloors.com)

## AUTHENTIC PLANK - WPC

**AUTHENTIC PLANK** is the ultimate waterproof flooring. A high density core, commercial grade wear layer and sound deadening attached pad are combined to offer the toughest and quietest product in the market. The 9" x 60" wide plank features an enhanced V groove bevel to complement the EIR - Embossed In Register technique that details every grain, knot and natural feature of the wood pattern. Offered in 6 traditional wood décors and 6 varied shade designer colors, all with a Lifetime Residential Warranty.

If you want a durable, waterproof product that exactly replicates the look of hardwood flooring, you deserve *AUTHENTIC Plank*.

### SPECIFICATIONS

- 8mm thick x 9" wide x 60" long
- 20 mil wear layer with double UV coating
- 2mm vinyl top layer
- 4.5mm composite core
- 1.5mm IXPE underlayment attached
- EIR detailed texture & graining
- V groove painted bevel
- Uniclic locking system
- Sq Ft per carton: 29.92
- Sq Ft per pallet: 1,795.20



## CLASSIC STRIP - WPC

### CLASSIC STRIP

If a rustic, wide plank look doesn't fit your needs, then *Classic Strip* is the option for you. Boasting a 3 1/4" width, mixed lengths, clean traditional visuals and a 70 board pattern repeat, *Classic Strip* offers the look of real, random length, solid hardwood floors with the durability and peace of mind of a waterproof warranty.

### SPECIFICATIONS

- 6.5mm thick with a 20 mil wear layer with double UV coating
- Width: 3.26" Narrow Strip
- Mixed Lengths: 19.69" / 39.37" / 60"
- 1.5mm vinyl top layer
- 4mm composite core
- 1mm IXPE underlayment attached
- EIR detailed texture & graining
- Micro bevel
- Uniclic locking system
- Sq Ft per carton: 21.66
- Sq Ft per pallet: 1,689.48



Trim and molding options available. See your Southwind Professional Dealer for details.

[SouthwindFloors.com](http://SouthwindFloors.com)

Trim and molding options available. See your Southwind Professional Dealer for details.

[SouthwindFloors.com](http://SouthwindFloors.com)

## HARBOR PLANK - WPC

**HARBOR PLANK** is the waterproof, composite core vinyl plank that changed the industry. It comes with a commercial grade wear layer, incredible core strength, and attached closed cell pad for superior noise reduction (IIC sound rating of 62db).

This product will not absorb moisture, mold or mildew. Now available in 21 unique colors, *Harbor Plank* is the perfect selection for your new waterproof floor.

### SPECIFICATIONS

- 8mm thick x 6" wide x 48" long
- 20 mil wear layer with double UV coating
- 1.5mm vinyl top layer
- 5mm composite core
- 1.5mm IXPE underlayment attached
- Uniclic locking system
- Sq Ft per carton: 15.76
- Sq Ft per pallet: 1,229.28



Trim and molding options available. See your Southwind Professional Dealer for details.

[SouthwindFloors.com](http://SouthwindFloors.com)

## TIMELESS PLANK - WPC

### TIMELESS PLANK

While boasting a waterproof composite core and attached IXPE Pad underlayment, *Timeless Plank* offers a great visual representation of real wood.

With a 12 mil wear layer, *Timeless Plank* is available in 6 unique colors and is a great option for your hard surface floor covering needs.

### SPECIFICATIONS

- 6.5mm thick x 6" wide x 48" long
- 1.5mm luxury vinyl top layer
- 4mm composite core
- 12 mil wear layer with double UV coating
- 1mm IXPE underlayment attached
- Detailed texture & graining
- Uniclic locking system
- Sq Ft per carton: 21.67
- Sq Ft per pallet: 1,191.74



Trim and molding options available. See your Southwind Professional Dealer for details.

[SouthwindFloors.com](http://SouthwindFloors.com)

# SPC FLOORING

Our Rigid Core SPC composite floors are second to none. The (Stone Plastic Composite) core construction is comprised of a generous amount of limestone and has a higher density rating in comparison to WPC. Its high density offers better resistance from scratches or dents from heavy items or furniture and makes it less susceptible to expansion in cases of extreme temperature change.

Built with the active household and commercial applications in mind, our SPC is topped with an industry leading wear layer technology and two coats of urethane finish. All of our SPC products are 100% waterproof and come with an attached underlayment and an easy click locking system. Lastly, cleaning and maintenance are a snap, requiring only regular sweeping and the occasional spot cleaning or mopping.



- 1 UV LAYER**  
Double UV coating for added scratch and fade protection.
- 2 WEAR LAYER**  
Protective Urethane Layer for stain and scratch resistance.
- 3 DÉCOR FILM**  
Realistic wood décor. Dent resistant.
- 4 COMPOSITE CORE**  
100% Waterproof.
- 5 UNDERLAYMENT**  
IXPE Closed Cell cushion for advanced Sound Absorption. Impervious to water. Hides subfloor imperfections.



## EQUITY PLANK - SPC

**EQUITY PLANK** strikes a perfect balance between beauty and toughness. Complete waterproof performance that is more dimensionally stable and offers superior indentation resistance. Combine this with unmatched styling and realistic EIR visuals and you may just have the perfect floor.

### SPECIFICATIONS

- 6mm thick x 9" wide x 60" long
- 20 mil wear layer with double UV coating
- 1mm IXPE underlayment
- EIR detailed texture & graining
- Uniclic locking system
- Sq Ft per carton: 22.44
- Sq Ft per pallet: 1,436.16



Trim and molding options available. See your Southwind Professional Dealer for details.

[SouthwindFloors.com](http://SouthwindFloors.com)

## RIGID PLUS - SPC

**RIGID PLUS** is the tough, dimensionally stable plank poised to replace traditional vinyl click. A 2000 kg/m density rating offers superior indentation resistance and virtually eliminates telegraphing. Easy to install over most existing hard surface floors, no required acclimation time, and no messy glue make *Rigid Plus* the perfect entry level Waterproof Floating Floor.

### SPECIFICATIONS

- 5mm thick x 7" wide x 48" long
- 20 mil wear layer with double UV coating
- 1mm EVA pad
- 2000+ kg/m density core
- Waterproof
- More rigid and stable than traditional vinyl click
- Resists indentations and telegraphing
- No acclimation needed
- Will not mold or mildew
- Installs over existing hard surface flooring
- Uniclic locking system
- Sq Ft per carton: 23.64
- Sq Ft per pallet: 1,182



## MAJESTIC PLANK - SPC

**MAJESTIC PLANK** is our most economical hard surface offering, but it's loaded with high end style and design options. With six total colors to choose from, this 3.2mm SPC core sports a 6 mil residential Urethane Wear Layer and an attached 1mm pad. Added wood grain texturing and we may have just created the perfect residential hard surface flooring option in the industry.

### SPECIFICATIONS

- 4.2mm thick x 6" wide x 48" long
- 1mm EVA Pad
- 6 mil wear layer with double UV coating
- Detailed texture & graining
- Uniclic locking system
- Sq Ft per carton: 23.64
- Sq Ft per pallet: 1,418.4

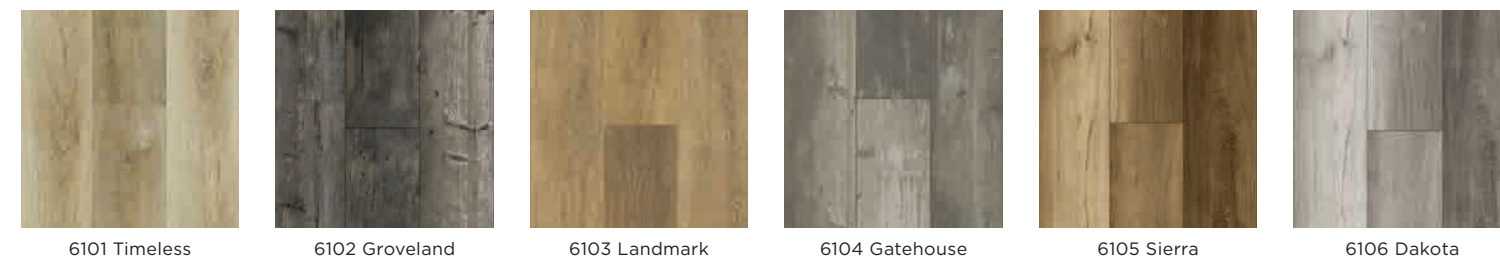

Trim and molding options available. See your Southwind Professional Dealer for details.

[SouthwindFloors.com](http://SouthwindFloors.com)

Trim and molding options available. See your Southwind Professional Dealer for details.

[SouthwindFloors.com](http://SouthwindFloors.com)

## LIBERTY PLANK - SPC

**LIBERTY PLANK** Proudly made in the U.S.A., Liberty Plank provides the quality workmanship you can trust for a lifetime. Constructed with a waterproof SPC core and a waterproof IXPE attached pad, Liberty Plank comes with a robust 20 mil wear layer to withstand the most active household. Realistic wood grain embossing combined with unique and versatile decor offers the perfect choice for any room in the home. Produced in 7.69" width by 60" in length, Liberty Plank looks great in any sized room.

### SPECIFICATIONS

- 5.5mm thick x 7.69" wide x 60" long
- 20 mil wear layer
- 1mm IXPE underlayment
- Uniclic locking system
- Sq Ft per carton: 28.84
- Sq Ft per pallet: 1,586.20



Indoor Air Quality Certification



Hatteras

**SPC**  
WaterProof Floors  
The Install Everywhere Floor™

**SPC**  
WaterProof Floors  
The Install Everywhere Floor™

Arctic Drift

## ADVANTAGE PLANK - SPC

**ADVANTAGE PLANK** Style. Quality. Performance. Advantage Plank boast a hearty 12 mil durable wear layer on a dense, waterproof SPC core for superior scratch and indentation protection. Wood grain texturing and beautifully crafted decor makes this floor the perfect addition to any room in your home. Naturally hygienic and easy to clean make this collection a great choice for homes with kids and pets. Available in 7" widths by 48" in length.

### SPECIFICATIONS

- 4.2mm thick x 7" wide x 48" long
- 12 mil wear layer
- 1mm EVA underlayment
- Sq Ft per carton: 28.37
- Sq Ft per pallet: 1,702.20



Indoor Air Quality Certification

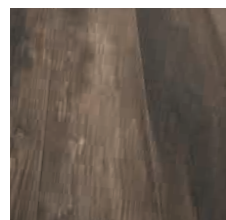

7001 Potomac

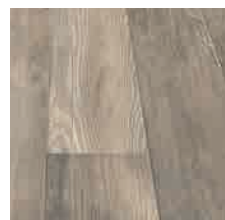

7002 Williamsburg



7003 Harpers Plank



7004 Jamestown



7005 Manassas

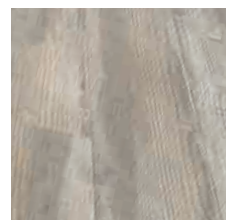

7006 Hatteras



6401 Arctic Drift



6402 Autumn Harvest

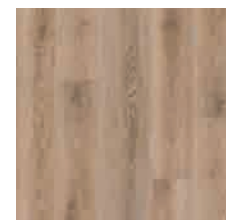

6403 Champagne Plank



6404 Canton Timber



6405 Mountain Ash



6406 Toasted Caramel

Trim and molding options available. See your Southwind Professional Dealer for details.

[SouthwindFloors.com](http://SouthwindFloors.com)

Trim and molding options available. See your Southwind Professional Dealer for details.

[SouthwindFloors.com](http://SouthwindFloors.com)

## ESSENCE PLANK - SPC

**ESSENCE PLANK** is constructed with a stone composite high-density 100% waterproof core with an Attached Underlayment. Essence Plank provides unmatched dimensional stability and indentation resistance while providing enhanced warmth and comfort underfoot. Featuring realistic embossing that adds a beautiful texturing to mimic real hardwood flooring, Essence Plank is available in 7" width by 60" length planks. Protected by a 20 mil wear layer, it can withstand all the abuse of an active household.

### SPECIFICATIONS

- 6mm thick x 7" wide x 60" long
- 20 mil wear layer
- 1mm IXPE underlayment
- EIR Embossing
- Sq Ft per carton: 23.62
- Sq Ft per pallet: 1,417.20



Dakota Hills

**XRP**<sup>®</sup>  
WaterProof Floors  
The Best. Everywhere. Floor.



Gravity



Whiskey



Sheer Mist



Timber Wolf

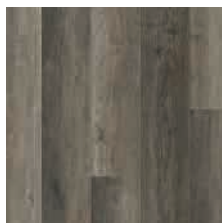

6501 Bluff View

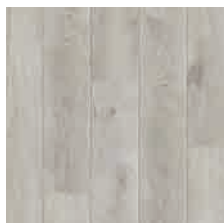

6502 City Trail



6503 Dakota Hills

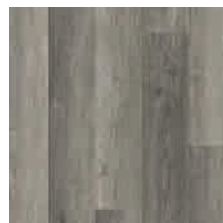

6504 Driftwood Oak



6505 Franklin Meadow

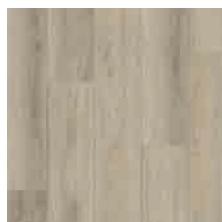

6506 Sunbleached Oak



6507 Sandcastle Oak

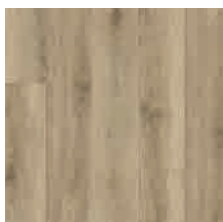

6508 Summer Wheat



6509 Tuscan Pecan

Trim and molding options available. See your Southwind Professional Dealer for details.

[SouthwindFloors.com](http://SouthwindFloors.com)

## WE'RE THINKING OUTSIDE THE BIG BOX!

YOU CAN TOO WHEN YOU BECOME A SOUTHWIND DEALER. OUR DUXXE BRAND OFFERS A WIDE VARIETY OF WATER- AND SCRATCH-RESILIENT LAMINATE FLOORING TO SUIT ANY HOME PROJECT.



LEARN MORE ABOUT BECOMING A SOUTHWIND PROFESSIONAL DEALER TODAY BY CALLING 800-272-2808.

[SOUTHWINDFLOORS.COM](http://SOUTHWINDFLOORS.COM)



## 12WRP - LAMINATE

Children playing, pets greeting you enthusiastically, a wine glass getting knocked over – life leaves its marks. The DUXXE scratch and water resilient laminate collection makes sure that you don't have to worry about little things like spills and leaks. The extraordinary water resilience paired with extreme durability, reliability and immaculate design makes for a flooring that can stand up to all of life's challenges. If you want the look and feel of realistic wood along with extra protection that can handle any active lifestyle, including a home with kids and pets, DUXXE brand offers you everything you could want and more.

### SPECIFICATIONS

- 14mm thick x 7.48" wide x 50.67" long
- 2mm Pad Attached
- AC4 Wear Rating EIR
- 4-Sided Bevel
- Unilin locking system
- Sq Ft per carton: 18.42
- Sq Ft per pallet: 663.12



White Smoke

**DUXXE**  
WATER AND SCRATCH RESILIENT FLOORING

## 8WR - LAMINATE

Children playing, pets greeting you enthusiastically, a wine glass getting knocked over – life leaves its marks. The DUXXE scratch and water resilient laminate collection makes sure that you don't have to worry about little things like spills and leaks. The extraordinary water resilience paired with extreme durability, reliability and immaculate design makes for a flooring that can stand up to all of life's challenges. If you want the look and feel of realistic wood along with extra protection that can handle any active lifestyle, including a home with kids and pets, DUXXE brand offers you everything you could want and more.

### SPECIFICATIONS

- 8mm thick x 7.48" wide x 50.67" long
- AC3 Wear Rating EIR
- 4-Sided Bevel
- Unilin locking system
- Sq Ft per carton: 23.69
- Sq Ft per pallet: 1231.88



Timber Wolf

**DUXXE**  
WATER AND SCRATCH RESILIENT FLOORING



01 - White Smoke

02 - Gravity

03 - Fleck Oak

04 - Beak

05 - Calico Hickory

06 - Whiskey



01 - Sheer Mist

02 - Timber Wolf

# LUXURY VINYL FLOORING

Available in 3 thicknesses (2mm, 3mm, and 5mm), we only use 100% virgin vinyl in our Luxury Vinyl products for superior durability and stability. This means there is no recycled content in the construction of our Luxury Vinyl products. It is phthalate free and void of heavy metal contaminants. Available in two installation methods, glue down or loose lay, there's something to offer for every application.

Each of our selections comes with Urethane Wear Layer and two coats of UV for lasting beauty and superior fade, scratch and stain resistance. Our Luxury Vinyl products are 100% waterproof and easy to maintain and clean.

## LOOSE LAY PLANK

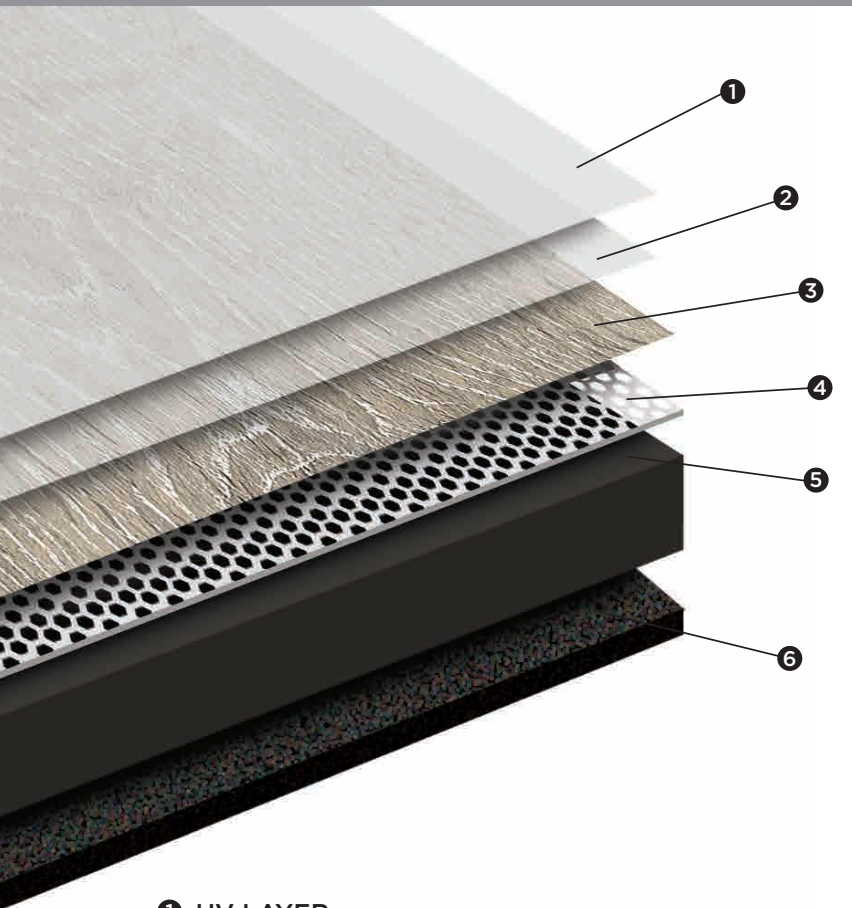

- 1 **UV LAYER**  
Double UV coating for added scratch and fade protection.
- 2 **WEAR LAYER**  
Protective Urethane Layer for stain and scratch resistance.
- 3 **DÉCOR FILM**  
Realistic wood décor. Dent resistant.
- 4 **FIBERGLASS LAYER**  
Mesh layer yields added strength and stability.
- 5 **PVC CORE**  
100% Virgin Vinyl.
- 6 **ANTI-SLIP BACKING**  
Provides dimensional stability and keeps flooring in place without the need for adhesives

## COLONIAL & HARVEST PLANK

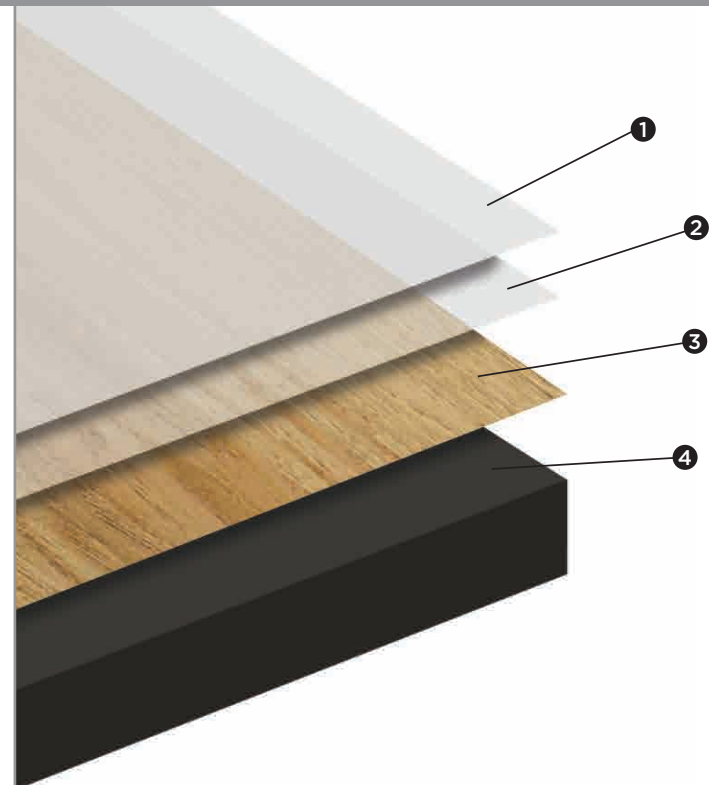

- 1 **UV LAYER**  
Double UV coating for added scratch and fade protection.
- 2 **WEAR LAYER**  
Protective Urethane Layer for stain and scratch resistance.
- 3 **DÉCOR FILM**  
Realistic wood décor. Dent resistant.
- 4 **PVC CORE**  
100% Virgin Vinyl with textured backing for superior adhesion.



## COLONIAL PLANK - LVP

**COLONIAL PLANK** is the perfect glue down option. Why settle for the typical bland colors available in most entry level products? *Colonial Plank* combines 12 exciting colorations with texture to provide elegant styling at an affordable price.

### SPECIFICATIONS

- 2mm thick x 6" wide x 48" long
- 6 mil wear layer with double UV coating
- Detailed texture & graining
- Square edge
- Glue down installation
- Sq Ft per carton: 36
- Sq Ft per pallet: 2,880

**WEAR LAYER** - 6 mil Urethane with double UV coating and Anti-Microbial finish. Superior fade, scratch and stain resistance. Easy to Clean.

**VINYL TOP LAYER** - Vinyl material, phthalate free. Durable, realistic wood décor.

**CONSTRUCTION** - Layered plank consisting of wear layer, film and backing.



Indoor Air Quality Certification

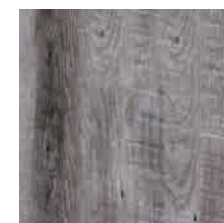

1001 Barnwood

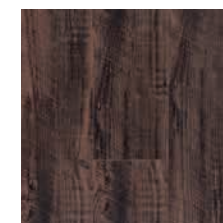

1002 Early American



1003 Honey



1004 Driftwood

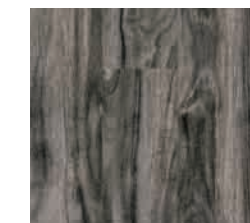

1006 Weathered Acacia



1007 Oyster Grey



1009 Homestead



1010 Hickory Hollow



1011 Heartland



1012 Rustic Retreat



1013 Ipswich Pine

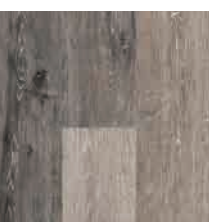

1014 Lumber Yard

Trim and molding options available. See your Southwind Professional Dealer for details.

## HARVEST PLANK - LVP

**HARVEST PLANK** is a true commercial workhorse with the latest designer features. A 20 mil wear layer, unique texture, V groove painted bevel, and realistic wood décor, assure that *Harvest Plank* will withstand the wear and tear of daily life in your home, office or commercial setting.

### SPECIFICATIONS

- 3mm thick x 6" wide x 48" long
- 20 mil wear layer with double UV coating
- V groove painted bevel
- Hand scraped texture
- Glue down installation
- Sq Ft per carton: 32
- Sq Ft per pallet: 1,536

**WEAR LAYER** - 20 mil Urethane with double UV coating and Anti-Microbial finish. Superior fade, scratch and stain resistance. Easy to Clean.

**VINYL TOP LAYER** - Phthalate free. Durable, realistic wood décor.

**TEXTURE** - Hand-Scraped, V Groove Painted Bevel



Heritage Grey

**FINALVINYL**  
WATERPROOF FLOORS LVP



Timberwood

**FINALVINYL**  
WATERPROOF FLOORS LVP

## LOOSE LAY PLANK - LVP

**LOOSE LAY PLANK** is our hassle free floor. It's quick and easy to install because it has a non-skid backing. It comes with NO clicking edge profile, and adhesives are not even necessary. Just simply install the product tight against the perimeter walls! It's durable, quiet, and dust free. If you ever need to replace a piece, simply pull it up!

### SPECIFICATIONS

- 5mm thick x 6" wide x 48" long
- 20 mil wear layer with double UV coating
- Fiberglass reinforced
- Non-skid backing
- Sq Ft per carton: 20
- Sq Ft per pallet: 1,200

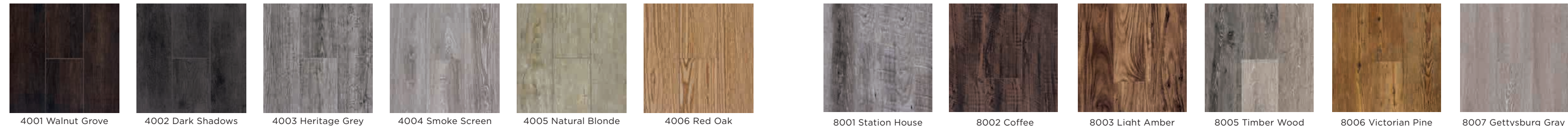

4001 Walnut Grove

4002 Dark Shadows

4003 Heritage Grey

4004 Smoke Screen

4005 Natural Blonde

4006 Red Oak

8001 Station House

8002 Coffee

8003 Light Amber

8005 Timber Wood

8006 Victorian Pine

8007 Gettysburg Gray

Trim and molding options available. See your Southwind Professional Dealer for details.

[SouthwindFloors.com](http://SouthwindFloors.com)

Trim and molding options available. See your Southwind Professional Dealer for details.

[SouthwindFloors.com](http://SouthwindFloors.com)



BRUSHSTROKES  
MATISSE



FILIGREE  
DÉCOR

CARPET

## AMBIENCE A106



This soft and stylish cut/uncut pattern is offered in an aura of 9 sparkling colorways. The pattern is created with pinpoint texture in the cut pile, and each block of the loop is accented on each side with a coordinating reflective shade. This all comes together to create a tactile and visual experience.

### PRODUCT SPECIFICATIONS\*

STYLE TYPE:	PRECISION CUT/UNCUT
FIBER:	100% CONTINUOUS FILAMENT SO SOFT™ PET
GAUGE:	1/8
WIDTH:	12 FT.
TUFTED YARN WEIGHT:	38 OZ. PER SQUARE YARD
PILE HEIGHT:	11/32" (CUT) 10/32" (LOOP)
DYEING PROCESS:	SOLUTION DYED
PRIMARY BACKING:	WOVEN POLYPROPYLENE
SECONDARY BACKING:	ACTIONBAC
PATTERN REPEAT (W x L):	1" W X 1 3/8" L
FLAMMABILITY:	PASSES PILL TEST (CPSC FF1-70, ASTM D-2859)

*\*All specifications are approximate and are subject to normal manufacturing tolerances not to exceed industry standards.*

### SPECIAL FEATURES

- SO SOFT™ PET MANUFACTURED EXCLUSIVELY BY SOUTHWIND FLOORS FOR LIFE
- SOLUTION DYED FIBER FOR SUPERIOR FADE RESISTANCE AND INHERENT STAIN RESISTANCE
- ECO FRIENDLY — VIRTUALLY WATERLESS MANUFACTURING PROCESS
- CARPET AND RUG INSTITUTE GREEN LABEL PLUS INDOOR AIR QUALITY CERTIFIED
- PERMANENT STATIC CONTROL
- SOIL PROTECTION

### WARRANTIES

- LIFETIME LIMITED STAIN RESISTANCE
- LIFETIME LIMITED SOIL RESISTANCE
- LIFETIME LIMITED ANTI-STATIC
- 25 YEAR LIMITED ABRASIVE WEAR
- 25 YEAR LIMITED TEXTURE RETENTION
- 25 YEAR LIMITED FADE RESISTANCE
- 25 YEAR LIMITED PET URINE STAIN RESISTANCE

*For complete warranty details, go to [www.SouthwindFloors.com](http://www.SouthwindFloors.com)*



1601 Atmosphere    1602 Frosted Gray    1603 Constellation    1604 Summer Glow    1605 Sparkling

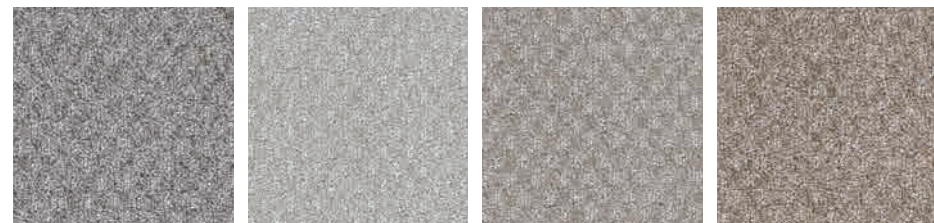

1606 Earth Dance    1607 Hilights    1608 Solstice    1609 Sunrise

## ARTISAN P165



Softness and beauty are in perfect harmony in this textural cut pile carpet. Available in 6 very useable colorways.

### PRODUCT SPECIFICATIONS\*

STYLE TYPE:	MULTICOLOR TEXTURED CUT PILE
FIBER:	100% CONTINUOUS FILAMENT SO SOFT™ PET
GAUGE:	1/8
WIDTH:	12 FT.
TUFTED YARN WEIGHT:	37 OZ. PER SQUARE YARD
PILE HEIGHT:	15/32"
DYEING PROCESS:	SOLUTION DYED
PRIMARY BACKING:	WOVEN POLYPROPYLENE
SECONDARY BACKING:	ACTION FLEECE
PATTERN REPEAT (W x L):	NONE
FLAMMABILITY:	PASSES PILL TEST (CPSC FF1-70, ASTM D-2859)

*\*All specifications are approximate and are subject to normal manufacturing tolerances not to exceed industry standards.*

### SPECIAL FEATURES

- SOLUTION DYED FIBER FOR SUPERIOR FADE RESISTANCE AND INHERENT STAIN RESISTANCE
- ECO FRIENDLY — VIRTUALLY WATERLESS MANUFACTURING PROCESS
- CARPET AND RUG INSTITUTE GREEN LABEL PLUS INDOOR AIR QUALITY CERTIFIED
- PERMANENT STATIC CONTROL
- SOIL PROTECTION

### WARRANTIES

- LIFETIME LIMITED STAIN RESISTANCE
- LIFETIME LIMITED SOIL RESISTANCE
- LIFETIME LIMITED ANTI-STATIC
- 25 YEAR LIMITED ABRASIVE WEAR
- 25 YEAR LIMITED TEXTURE RETENTION
- 25 YEAR LIMITED FADE RESISTANCE
- 25 YEAR LIMITED PET URINE STAIN RESISTANCE

*For complete warranty details, go to [www.southwindfloors.com](http://www.southwindfloors.com)*



6501 Canvas    6502 Brushed Silver    6503 Showcase    6504 Macrame    6505 Craft Paper    6506 Terra

**BRUSHSTROKES L167**



LCL (Level Cut and Loop) styled in a random geometric pattern created with subtle layers of cut and loop. Available in 5 fashionable colors.

**PRODUCT SPECIFICATIONS\***

STYLE TYPE:	PATTERNED LEVEL CUT & LOOP
FIBER:	100% CONTINUOUS FILAMENT SO SOFT™ PET
GAUGE:	1/10
WIDTH:	12 FT.
TUFTED YARN WEIGHT:	36 OZ. PER SQUARE YARD
PILE HEIGHT:	9.5/32"
DYEING PROCESS:	SOLUTION DYED
PRIMARY BACKING:	WOVEN POLYPROPYLENE
SECONDARY BACKING:	ACTION FLEECE
PATTERN REPEAT (W x L):	11 4/5" W X 20 1/2" L
FLAMMABILITY:	PASSES PILL TEST (CPSC FF1-70, ASTM D-2859)

*\*All specifications are approximate and are subject to normal manufacturing tolerances not to exceed industry standards.*

**SPECIAL FEATURES**

- SOLUTION DYED FIBER FOR SUPERIOR FADE RESISTANCE AND INHERENT STAIN RESISTANCE
- ECO FRIENDLY — VIRTUALLY WATERLESS MANUFACTURING PROCESS
- CARPET AND RUG INSTITUTE GREEN LABEL PLUS INDOOR AIR QUALITY CERTIFIED
- PERMANENT STATIC CONTROL
- SOIL PROTECTION

**WARRANTIES**

- LIFETIME LIMITED STAIN RESISTANCE
- LIFETIME LIMITED SOIL RESISTANCE
- 25 YEAR LIMITED ABRASIVE WEAR
- 25 YEAR LIMITED TEXTURE RETENTION
- 25 YEAR LIMITED FADE RESISTANCE
- 25 YEAR LIMITED PET URINE STAIN RESISTANCE

*For complete warranty details, go to [www.southwindfloors.com](http://www.southwindfloors.com)*



6701 Aesthetics    6703 Painterly    6704 Composition    6705 Matisse    6706 Collage

**CALLAWAY II S263**



Classic hobnail textural loop carpet with hand-crafted appeal, in a palette of 6 natural heather colorations, including new grays and neutrals.

**PRODUCT SPECIFICATIONS\***

STYLE TYPE:	TEXTURED LOOP BERBER
FIBER:	100% BCF SD-XTRA® POLYPROPYLENE
GAUGE:	1/5
WIDTH:	12 FT.
TUFTED YARN WEIGHT:	32 OZ. PER SQUARE YARD
PILE HEIGHT:	12/32" (HIGH) 5/32" (LOW)
DYEING PROCESS:	SOLUTION DYED
PRIMARY BACKING:	WOVEN POLYPROPYLENE
SECONDARY BACKING:	ACTIONBAC
PATTERN REPEAT (W x L):	2/5" W X 3/4" L
FLAMMABILITY:	PASSES PILL TEST (CPSC FF1-70, ASTM D-2859)

*\*All specifications are approximate and are subject to normal manufacturing tolerances not to exceed industry standards.*

**SPECIAL FEATURES**

- SD-XTRA® POLYPROPYLENE — SOLUTION DYED FIBER FOR SUPERIOR FADE RESISTANCE AND INHERENT STAIN RESISTANCE
- ECO FRIENDLY — VIRTUALLY WATERLESS MANUFACTURING PROCESS
- CARPET AND RUG INSTITUTE GREEN LABEL PLUS INDOOR AIR QUALITY CERTIFIED
- PERMANENT STATIC CONTROL

**WARRANTIES**

- 10 YEAR LIMITED WEAR
- 10 YEAR LIMITED STAIN

*For complete warranty details, go to [www.southwindfloors.com](http://www.southwindfloors.com)*



6301 Greystone    6302 Granite    6303 Marble    6304 Oakwood    6308 Quartz    6309 Summit

**CAMBRIDGE II S261**



Two yarns create a richly-textured loop carpet pattern that is slightly shifted for a subtle mix of color play. Available in 6 neutral color pairings.

**PRODUCT SPECIFICATIONS\***

STYLE TYPE:	TEXTURED LOOP BERBER
FIBER:	100% BCF SD-XTRA <sup>®</sup> POLYPROPYLENE
GAUGE:	3/16
WIDTH:	12 FT.
TUFTED YARN WEIGHT:	27 OZ. PER SQUARE YARD
PILE HEIGHT:	12/32" (HIGH) 6/32" (LOW)
DYEING PROCESS:	SOLUTION DYED
PRIMARY BACKING:	WOVEN POLYPROPYLENE
SECONDARY BACKING:	ACTIONBAC
PATTERN REPEAT (W x L):	3/4" W X 1" L
FLAMMABILITY:	PASSES PILL TEST (CPSC FF1-70, ASTM D-2859)

*\*All specifications are approximate and are subject to normal manufacturing tolerances not to exceed industry standards.*

**SPECIAL FEATURES**

- SD-XTRA<sup>®</sup> POLYPROPYLENE — SOLUTION DYED FIBER FOR SUPERIOR FADE RESISTANCE AND INHERENT STAIN RESISTANCE
- ECO FRIENDLY — VIRTUALLY WATERLESS MANUFACTURING PROCESS
- CARPET AND RUG INSTITUTE GREEN LABEL PLUS INDOOR AIR QUALITY CERTIFIED
- PERMANENT STATIC CONTROL

**WARRANTIES**

- 10 YEAR LIMITED WEAR
- 10 YEAR LIMITED STAIN

*For complete warranty details, go to [www.southwindfloors.com](http://www.southwindfloors.com)*



6104 Keystone    6105 Ice Ballet    6111 Tradition    6113 Cobblestone    6114 Diplomat    6115 Classic

**CROSS WEAVE L141**



This LCL (Level Cut and Loop) pattern is a very striking and fashionable "fabric" for the floor, with random combos of texture and color, and is designed with So Soft™ solution-dyed PET yarn. Available in 5 harmonious color combinations.

**PRODUCT SPECIFICATIONS\***

STYLE TYPE:	PATTERNED LEVEL CUT & LOOP
FIBER:	100% CONTINUOUS FILAMENT SO SOFT™ PET
GAUGE:	1/10
WIDTH:	12 FT.
TUFTED YARN WEIGHT:	36 OZ. PER SQUARE YARD
PILE HEIGHT:	12/32" (CUT) 8/32" (LOOP)
DYEING PROCESS:	SOLUTION DYED
PRIMARY BACKING:	WOVEN POLYPROPYLENE
SECONDARY BACKING:	ACTIONBAC
PATTERN REPEAT (W x L):	16" W X 22" L
FLAMMABILITY:	PASSES PILL TEST (CPSC FF1-70, ASTM D-2859)

*\*All specifications are approximate and are subject to normal manufacturing tolerances not to exceed industry standards.*

**SPECIAL FEATURES**

- SO SOFT™ PET MANUFACTURED EXCLUSIVELY BY SOUTHWIND FLOORS FOR LIFE
- SOLUTION DYED FIBER FOR SUPERIOR FADE RESISTANCE AND INHERENT STAIN RESISTANCE
- ECO FRIENDLY — VIRTUALLY WATERLESS MANUFACTURING PROCESS
- CARPET AND RUG INSTITUTE GREEN LABEL PLUS INDOOR AIR QUALITY CERTIFIED
- SOIL PROTECTION

**WARRANTIES**

- LIFETIME LIMITED STAIN RESISTANCE
- LIFETIME LIMITED SOIL RESISTANCE
- 25 YEAR LIMITED ABRASIVE WEAR
- 25 YEAR LIMITED TEXTURE RETENTION
- 25 YEAR LIMITED FADE RESISTANCE
- 25 YEAR LIMITED PET URINE STAIN RESISTANCE

*For complete warranty details, go to [www.SouthwindFloors.com](http://www.SouthwindFloors.com)*



4106 Woolen    4107 Platinum    4109 Twill    4111 Antiquity    4113 Tapestry

**ENCHANTING P255**



*You must see and feel this carpet to experience its sophistication and beauty. It is truly enchanting to the touch and to the eye. Styled in So Soft™ solution-dyed PET in a nice, tight, dense construction, it is fashioned with multi-tonal yarns in 7 on-trend colorways.*

**PRODUCT SPECIFICATIONS\***

STYLE TYPE:	TEXTURED CUT PILE
FIBER:	100% CONTINUOUS FILAMENT SO SOFT™ PET
GAUGE:	1/10
WIDTH:	12 FT.
TUFTED YARN WEIGHT:	62 OZ. PER SQUARE YARD
PILE HEIGHT:	19/32"
DYEING PROCESS:	SOLUTION DYED
PRIMARY BACKING:	WOVEN POLYPROPYLENE
SECONDARY BACKING:	COMFORT BACK
PATTERN REPEAT (W X L):	NONE
FLAMMABILITY:	PASSES PILL TEST (CPSC FF1-70, ASTM D-2859)

*\*All specifications are approximate and are subject to normal manufacturing tolerances not to exceed industry standards.*

**SPECIAL FEATURES**

- SOLUTION DYED FIBER FOR SUPERIOR FADE RESISTANCE AND INHERENT STAIN RESISTANCE
- ECO FRIENDLY — VIRTUALLY WATERLESS MANUFACTURING PROCESS
- CARPET AND RUG INSTITUTE GREEN LABEL PLUS INDOOR AIR QUALITY CERTIFIED

**WARRANTIES**

- LIFETIME LIMITED STAIN RESISTANCE
- LIFETIME LIMITED SOIL RESISTANCE
- LIFETIME LIMITED ANTI-STATIC
- 25 YEAR LIMITED ABRASIVE WEAR
- 25 YEAR LIMITED TEXTURE RETENTION
- 25 YEAR LIMITED FADE RESISTANCE
- 25 YEAR LIMITED PET URINE STAIN RESISTANCE

*For complete warranty details, go to [www.SouthwindFloors.com](http://www.SouthwindFloors.com)*

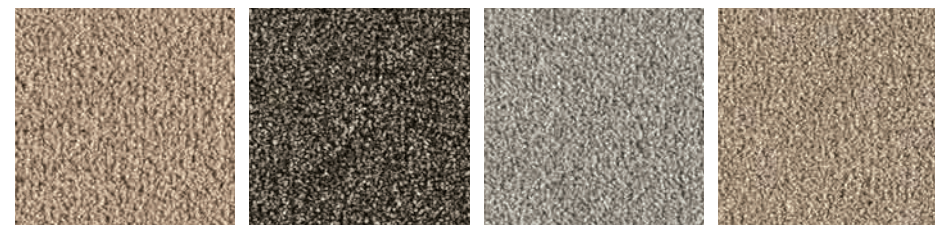

5501 Natural Wonder   5502 Midnight Hour   5503 Silver Strand   5504 Neutrality



5505 Stormy   5506 Amazing Gray   5507 Perfect Taupe

**EXOTIC GLOW A152**

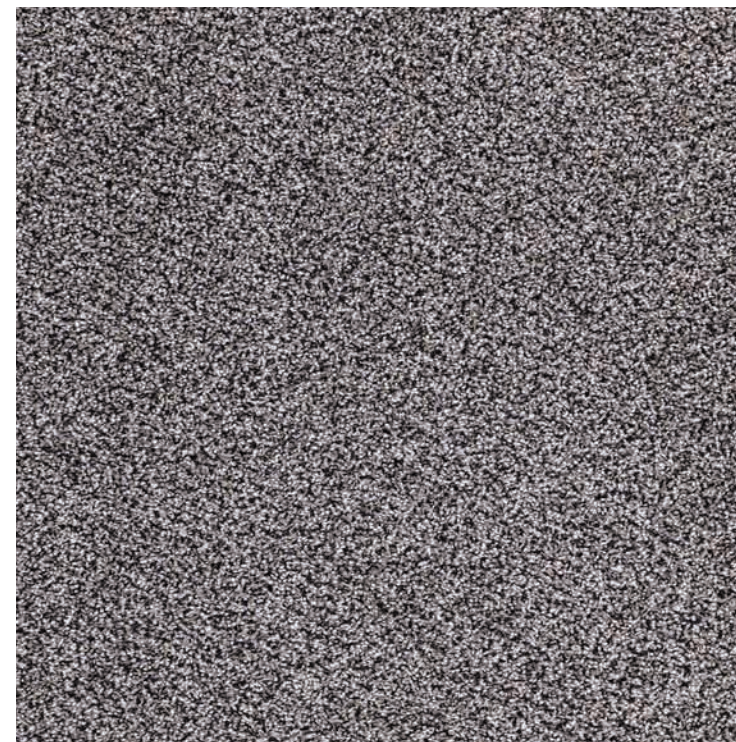

*This smooth cut pile carpet is a winner for volumes of universal appeal. Made of So Soft™ Pet for softness and beauty in 8 intermingled color combinations.*

**PRODUCT SPECIFICATIONS\***

STYLE TYPE:	MULTICOLOR TEXTURED CUT PILE
FIBER:	100% CONTINUOUS FILAMENT SO SOFT™ PET
GAUGE:	3/16
WIDTH:	12 FT.
TUFTED YARN WEIGHT:	50 OZ. PER SQUARE YARD
PILE HEIGHT:	24/32"
DYEING PROCESS:	SOLUTION DYED
PRIMARY BACKING:	WOVEN POLYPROPYLENE
SECONDARY BACKING:	ACTIONBAC
PATTERN REPEAT (W X L):	NONE
FLAMMABILITY:	PASSES PILL TEST (CPSC FF1-70, ASTM D-2859)

*\*All specifications are approximate and are subject to normal manufacturing tolerances not to exceed industry standards.*

**SPECIAL FEATURES**

- SO SOFT™ PET MANUFACTURED EXCLUSIVELY BY SOUTHWIND FLOORS FOR LIFE
- SOLUTION DYED FIBER FOR SUPERIOR FADE RESISTANCE AND INHERENT STAIN RESISTANCE
- ECO FRIENDLY — VIRTUALLY WATERLESS MANUFACTURING PROCESS
- CARPET AND RUG INSTITUTE GREEN LABEL PLUS INDOOR AIR QUALITY CERTIFIED
- PERMANENT STATIC CONTROL
- SOIL PROTECTION

**WARRANTIES**

- LIFETIME LIMITED STAIN RESISTANCE
- LIFETIME LIMITED SOIL RESISTANCE
- LIFETIME LIMITED ANTI-STATIC
- 25 YEAR LIMITED ABRASIVE WEAR
- 25 YEAR LIMITED TEXTURE RETENTION
- 25 YEAR LIMITED FADE RESISTANCE
- 25 YEAR LIMITED PET URINE STAIN RESISTANCE

*For complete warranty details, go to [www.SouthwindFloors.com](http://www.SouthwindFloors.com)*



5201 Quiet Dawn   5202 Mineral Mix   5203 Global Earth   5204 Desert Escape   5205 Sparkling Mist

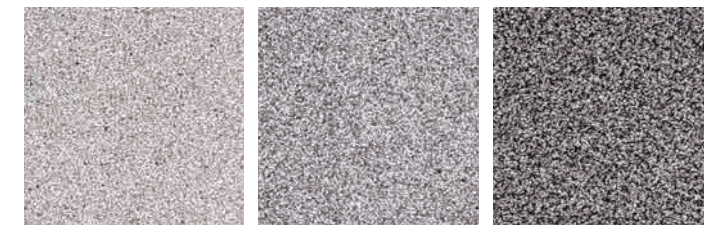

5206 Winter Fog   5207 Classic Blend   5208 Abyss



**FAIRVIEW L134**



*This LCL (Level Cut and Loop) So Soft™ solution-dyed PET carpet is styled in a textural pattern that is an over-all universal look for any application. Created with 5 solid and tone-on tone yarn combinations for interest on the floor.*

**PRODUCT SPECIFICATIONS\***

STYLE TYPE:	PATTERNED LEVEL CUT & LOOP
FIBER:	100% CONTINUOUS FILAMENT SO SOFT™ PET
GAUGE:	1/10
WIDTH:	12 FT.
TUFTED YARN WEIGHT:	36 OZ. PER SQUARE YARD
PILE HEIGHT:	12/32" (CUT) 8/32" (LOOP)
DYEING PROCESS:	SOLUTION DYED
PRIMARY BACKING:	WOVEN POLYPROPYLENE
SECONDARY BACKING:	ACTIONBAC
PATTERN REPEAT (W x L):	9 1/2" W x 25" L
FLAMMABILITY:	PASSES PILL TEST (CPSC FF1-70, ASTM D-2859)

*\*All specifications are approximate and are subject to normal manufacturing tolerances not to exceed industry standards.*

**SPECIAL FEATURES**

- SO SOFT™ PET MANUFACTURED EXCLUSIVELY BY SOUTHWIND FLOORS FOR LIFE
- SOLUTION DYED FIBER FOR SUPERIOR FADE RESISTANCE AND INHERENT STAIN RESISTANCE
- ECO FRIENDLY — VIRTUALLY WATERLESS MANUFACTURING PROCESS
- CARPET AND RUG INSTITUTE GREEN LABEL PLUS INDOOR AIR QUALITY CERTIFIED
- SOIL PROTECTION

**WARRANTIES**

- LIFETIME LIMITED STAIN RESISTANCE
- LIFETIME LIMITED SOIL RESISTANCE
- 25 YEAR LIMITED ABRASIVE WEAR
- 25 YEAR LIMITED TEXTURE RETENTION
- 25 YEAR LIMITED FADE RESISTANCE
- 25 YEAR LIMITED PET URINE STAIN RESISTANCE

*For complete warranty details, go to [www.SouthwindFloors.com](http://www.SouthwindFloors.com)*



**FILIGREE L139**



*This LCL (Level Cut and Loop) So Soft™ solution-dyed PET carpet is styled in a very attractive random grid pattern. This pattern with its 5 tonal solid/tweed colorations creates a textural treat that can be used in multiple styles of décor.*

**PRODUCT SPECIFICATIONS\***

STYLE TYPE:	PATTERNED LEVEL CUT & LOOP
FIBER:	100% CONTINUOUS FILAMENT SO SOFT™ PET
GAUGE:	1/10
WIDTH:	12 FT.
TUFTED YARN WEIGHT:	36 OZ. PER SQUARE YARD
PILE HEIGHT:	10/32" (CUT) 8/32" (LOOP)
DYEING PROCESS:	SOLUTION DYED
PRIMARY BACKING:	WOVEN POLYPROPYLENE
SECONDARY BACKING:	ACTIONBAC
PATTERN REPEAT (W X L):	24" W X 24 3/4" L
FLAMMABILITY:	PASSES PILL TEST (CPSC FF1-70, ASTM D-2859)

*\*All specifications are approximate and are subject to normal manufacturing tolerances not to exceed industry standards.*

**SPECIAL FEATURES**

- SO SOFT™ PET MANUFACTURED EXCLUSIVELY BY SOUTHWIND FLOORS FOR LIFE
- SOLUTION DYED FIBER FOR SUPERIOR FADE RESISTANCE AND INHERENT STAIN RESISTANCE
- ECO FRIENDLY — VIRTUALLY WATERLESS MANUFACTURING PROCESS
- CARPET AND RUG INSTITUTE GREEN LABEL PLUS INDOOR AIR QUALITY CERTIFIED
- SOIL PROTECTION

**WARRANTIES**

- LIFETIME LIMITED STAIN RESISTANCE
- LIFETIME LIMITED SOIL RESISTANCE
- 25 YEAR LIMITED ABRASIVE WEAR
- 25 YEAR LIMITED TEXTURE RETENTION
- 25 YEAR LIMITED FADE RESISTANCE
- 25 YEAR LIMITED PET URINE STAIN RESISTANCE

*For complete warranty details, go to [www.SouthwindFloors.com](http://www.SouthwindFloors.com)*



**FINESSE P168**



*Pleasing balance of color in a soft tight-dense textural cut pile carpet. Available in a palette of 6 appealing grays and neutrals.*

**PRODUCT SPECIFICATIONS\***

STYLE TYPE:	MULTICOLOR TEXTURED CUT PILE
FIBER:	100% CONTINUOUS FILAMENT SO SOFT™ PET
GAUGE:	1/8
WIDTH:	12 FT.
TUFTED YARN WEIGHT:	60 OZ. PER SQUARE YARD
PILE HEIGHT:	16.5/32"
DYEING PROCESS:	SOLUTION DYED
PRIMARY BACKING:	WOVEN POLYPROPYLENE
SECONDARY BACKING:	ACTION FLEECE
PATTERN REPEAT (W x L):	NONE
FLAMMABILITY:	PASSES PILL TEST (CPSC FF1-70, ASTM D-2859)

*\*All specifications are approximate and are subject to normal manufacturing tolerances not to exceed industry standards.*

**SPECIAL FEATURES**

- SOLUTION DYED FIBER FOR SUPERIOR FADE RESISTANCE AND INHERENT STAIN RESISTANCE
- ECO FRIENDLY — VIRTUALLY WATERLESS MANUFACTURING PROCESS
- CARPET AND RUG INSTITUTE GREEN LABEL PLUS INDOOR AIR QUALITY CERTIFIED
- PERMANENT STATIC CONTROL
- SOIL PROTECTION

**WARRANTIES**

- LIFETIME LIMITED STAIN RESISTANCE
- LIFETIME LIMITED SOIL RESISTANCE
- LIFETIME LIMITED ANTI-STATIC
- 25 YEAR LIMITED ABRASIVE WEAR
- 25 YEAR LIMITED TEXTURE RETENTION
- 25 YEAR LIMITED FADE RESISTANCE
- 25 YEAR LIMITED PET URINE STAIN RESISTANCE

*For complete warranty details, go to [www.southwindfloors.com](http://www.southwindfloors.com)*



6801 Mystique    6802 Beauty    6803 Elegance    6804 Enticing    6805 Glamour    6806 Vogue

**GALLERY P166**



*This soft, textural cut pile tweed carpet is a natural classic with charming appeal. Available in a selection of 6 tone-on-tone grays and neutrals.*

**PRODUCT SPECIFICATIONS\***

STYLE TYPE:	MULTICOLOR TEXTURED CUT PILE
FIBER:	100% CONTINUOUS FILAMENT SO SOFT™ PET
GAUGE:	1/8
WIDTH:	12 FT.
TUFTED YARN WEIGHT:	46 OZ. PER SQUARE YARD
PILE HEIGHT:	16.5/32"
DYEING PROCESS:	SOLUTION DYED
PRIMARY BACKING:	WOVEN POLYPROPYLENE
SECONDARY BACKING:	ACTION FLEECE
PATTERN REPEAT (W x L):	NONE
FLAMMABILITY:	PASSES PILL TEST (CPSC FF1-70, ASTM D-2859)

*\*All specifications are approximate and are subject to normal manufacturing tolerances not to exceed industry standards.*

**SPECIAL FEATURES**

- SOLUTION DYED FIBER FOR SUPERIOR FADE RESISTANCE AND INHERENT STAIN RESISTANCE
- ECO FRIENDLY — VIRTUALLY WATERLESS MANUFACTURING PROCESS
- CARPET AND RUG INSTITUTE GREEN LABEL PLUS INDOOR AIR QUALITY CERTIFIED
- PERMANENT STATIC CONTROL
- SOIL PROTECTION

**WARRANTIES**

- LIFETIME LIMITED STAIN RESISTANCE
- LIFETIME LIMITED SOIL RESISTANCE
- LIFETIME LIMITED ANTI-STATIC
- 25 YEAR LIMITED ABRASIVE WEAR
- 25 YEAR LIMITED TEXTURE RETENTION
- 25 YEAR LIMITED FADE RESISTANCE
- 25 YEAR LIMITED PET URINE STAIN RESISTANCE

*For complete warranty details, go to [www.southwindfloors.com](http://www.southwindfloors.com)*



6601 Terrace    6602 Boardwalk    6603 Open House    6604 Veranda    6605 Arcade    6606 Promenade

**GLOBAL IMAGE A153**



A true tactile and visual experience with 70 ounces of So Soft™ PET luxury to sink your toes into 8 cross-tones of color pair to create fashion and sophistication.

**PRODUCT SPECIFICATIONS\***

STYLE TYPE:	MULTICOLOR TEXTURED CUT PILE
FIBER:	100% CONTINUOUS FILAMENT SO SOFT™ PET
GAUGE:	3/16
WIDTH:	12 FT.
TUFTED YARN WEIGHT:	70 OZ. PER SQUARE YARD
PILE HEIGHT:	27/32"
DYEING PROCESS:	SOLUTION DYED
PRIMARY BACKING:	WOVEN POLYPROPYLENE
SECONDARY BACKING:	ACTIONBAC
PATTERN REPEAT (W X L):	NONE
FLAMMABILITY:	PASSES PILL TEST (CPSC FF1-70, ASTM D-2859)

*\*All specifications are approximate and are subject to normal manufacturing tolerances not to exceed industry standards.*

**SPECIAL FEATURES**

- SO SOFT™ PET MANUFACTURED EXCLUSIVELY BY SOUTHWIND FLOORS FOR LIFE
- SOLUTION DYED FIBER FOR SUPERIOR FADE RESISTANCE AND INHERENT STAIN RESISTANCE
- ECO FRIENDLY — VIRTUALLY WATERLESS MANUFACTURING PROCESS
- CARPET AND RUG INSTITUTE GREEN LABEL PLUS INDOOR AIR QUALITY CERTIFIED
- PERMANENT STATIC CONTROL
- SOIL PROTECTION

**WARRANTIES**

- LIFETIME LIMITED STAIN RESISTANCE
- LIFETIME LIMITED SOIL RESISTANCE
- LIFETIME LIMITED ANTI-STATIC
- 25 YEAR LIMITED ABRASIVE WEAR
- 25 YEAR LIMITED TEXTURE RETENTION
- 25 YEAR LIMITED FADE RESISTANCE
- 25 YEAR LIMITED PET URINE STAIN RESISTANCE

*For complete warranty details, go to [www.SouthwindFloors.com](http://www.SouthwindFloors.com)*



5301 Daylight    5302 Natural Resource    5303 Earthscape    5304 Bountiful    5305 Dream Cloud



5306 Soothing Mist    5307 Grey Matter    5308 Deep Space

**HIGHLIGHTS A115**



Accents of soft, tonal texture create balance and harmony in this stylish cut pile carpet. Designed in 9 colors of nature including popular blue and green for versatility and fashion.

**PRODUCT SPECIFICATIONS\***

STYLE TYPE:	TONAL TEXTURED CUT PILE
FIBER:	100% CONTINUOUS FILAMENT SO SOFT™ PET
GAUGE:	1/8
WIDTH:	12 FT.
TUFTED YARN WEIGHT:	37 OZ. PER SQUARE YARD
PILE HEIGHT:	20/32"
DYEING PROCESS:	SOLUTION DYED
PRIMARY BACKING:	WOVEN POLYPROPYLENE
SECONDARY BACKING:	ACTIONBAC
PATTERN REPEAT (W X L):	NONE
FLAMMABILITY:	PASSES PILL TEST (CPSC FF1-70, ASTM D-2859)

*\*All specifications are approximate and are subject to normal manufacturing tolerances not to exceed industry standards.*

**SPECIAL FEATURES**

- SO SOFT™ PET MANUFACTURED EXCLUSIVELY BY SOUTHWIND FLOORS FOR LIFE
- SOLUTION DYED FIBER FOR SUPERIOR FADE RESISTANCE AND INHERENT STAIN RESISTANCE
- ECO FRIENDLY — VIRTUALLY WATERLESS MANUFACTURING PROCESS
- CARPET AND RUG INSTITUTE GREEN LABEL PLUS INDOOR AIR QUALITY CERTIFIED
- PERMANENT STATIC CONTROL
- SOIL PROTECTION

**WARRANTIES**

- LIFETIME LIMITED STAIN RESISTANCE
- LIFETIME LIMITED SOIL RESISTANCE
- LIFETIME LIMITED ANTI-STATIC
- 25 YEAR LIMITED ABRASIVE WEAR
- 25 YEAR LIMITED TEXTURE RETENTION
- 25 YEAR LIMITED FADE RESISTANCE
- 25 YEAR LIMITED PET URINE STAIN RESISTANCE

*For complete warranty details, go to [www.SouthwindFloors.com](http://www.SouthwindFloors.com)*



5001 Glowing    5002 Moondust    5003 Tones    5004 Super Star    5005 Laser



5006 Horizon    5007 Luminous    5008 Nature Show    5009 Accents

**INTRIGUE A117**



*INTRIGUE is designed with pops of textural organic accents and styled with softness for universal appeal. 8 on-trend colorations for endless applications.*

**PRODUCT SPECIFICATIONS\***

STYLE TYPE:	MULTICOLOR TEXTURED CUT PILE
FIBER:	100% CONTINUOUS FILAMENT SO SOFT™ PET
GAUGE:	1/10
WIDTH:	12 FT.
TUFTED YARN WEIGHT:	42 OZ. PER SQUARE YARD
PILE HEIGHT:	22/32"
DYEING PROCESS:	SOLUTION DYED
PRIMARY BACKING:	WOVEN POLYPROPYLENE
SECONDARY BACKING:	ACTIONBAC
PATTERN REPEAT (W x L):	NONE
FLAMMABILITY:	PASSES PILL TEST (CPSC FF1-70, ASTM D-2859)

*\*All specifications are approximate and are subject to normal manufacturing tolerances not to exceed industry standards.*

**SPECIAL FEATURES**

- SO SOFT™ PET MANUFACTURED EXCLUSIVELY BY SOUTHWIND FLOORS FOR LIFE
- SOLUTION DYED FIBER FOR SUPERIOR FADE RESISTANCE AND INHERENT STAIN RESISTANCE
- ECO FRIENDLY – VIRTUALLY WATERLESS MANUFACTURING PROCESS
- CARPET AND RUG INSTITUTE GREEN LABEL PLUS INDOOR AIR QUALITY CERTIFIED
- PERMANENT STATIC CONTROL
- SOIL PROTECTION

**WARRANTIES**

- LIFETIME LIMITED STAIN RESISTANCE
- LIFETIME LIMITED SOIL RESISTANCE
- LIFETIME LIMITED ANTI-STATIC
- 25 YEAR LIMITED ABRASIVE WEAR
- 25 YEAR LIMITED TEXTURE RETENTION
- 25 YEAR LIMITED FADE RESISTANCE
- 25 YEAR LIMITED PET URINE STAIN RESISTANCE

*For complete warranty details, go to [www.SouthwindFloors.com](http://www.SouthwindFloors.com)*



7001 Charm    7002 Allure    7003 Hypnotic    7004 Showstopper    7005 Wonder



7006 Mystere    7007 Opulence    7008 Epic

**LAUREL FALLS L135**



*Organic LCL (Level Cut and Loop) pattern is created with variations of cut and loop and solid and tonal yarn combinations. Available in 5 soft colorways.*

**PRODUCT SPECIFICATIONS\***

STYLE TYPE:	PATTERNED LEVEL CUT & LOOP
FIBER:	100% CONTINUOUS FILAMENT SO SOFT™ PET
GAUGE:	1/10
WIDTH:	12 FT.
TUFTED YARN WEIGHT:	36 OZ. PER SQUARE YARD
PILE HEIGHT:	12/32" (CUT) 10/32" (LOOP)
DYEING PROCESS:	SOLUTION DYED
PRIMARY BACKING:	WOVEN POLYPROPYLENE
SECONDARY BACKING:	ACTIONBAC
PATTERN REPEAT (W x L):	16" W x 14 1/4" L
FLAMMABILITY:	PASSES PILL TEST (CPSC FF1-70, ASTM D-2859)

*\*All specifications are approximate and are subject to normal manufacturing tolerances not to exceed industry standards.*

**SPECIAL FEATURES**

- SO SOFT™ PET MANUFACTURED EXCLUSIVELY BY SOUTHWIND FLOORS FOR LIFE
- SOLUTION DYED FIBER FOR SUPERIOR FADE RESISTANCE AND INHERENT STAIN RESISTANCE
- ECO FRIENDLY – VIRTUALLY WATERLESS MANUFACTURING PROCESS
- CARPET AND RUG INSTITUTE GREEN LABEL PLUS INDOOR AIR QUALITY CERTIFIED
- SOIL PROTECTION

**WARRANTIES**

- LIFETIME LIMITED STAIN RESISTANCE
- LIFETIME LIMITED SOIL RESISTANCE
- 25 YEAR LIMITED ABRASIVE WEAR
- 25 YEAR LIMITED TEXTURE RETENTION
- 25 YEAR LIMITED FADE RESISTANCE
- 25 YEAR LIMITED PET URINE STAIN RESISTANCE

*For complete warranty details, go to [www.SouthwindFloors.com](http://www.SouthwindFloors.com)*



3505 Sheer Beauty    3506 Fresh Taupe    3507 Sparkling Dew    3508 Natural Gray    3509 River Rock

## LIGHT SHOW A104



*You can almost see the light dance off of this tone-on-tone beauty. The show of light enhancement creates pixels of color in 12 harmonious shades.*

### PRODUCT SPECIFICATIONS\*

STYLE TYPE:	TONAL TEXTURED CUT PILE
FIBER:	100% CONTINUOUS FILAMENT SO SOFT™ PET
GAUGE:	3/16
WIDTH:	12 FT.
TUFTED YARN WEIGHT:	50 OZ. PER SQUARE YARD
PILE HEIGHT:	24/32"
DYEING PROCESS:	SOLUTION DYED
PRIMARY BACKING:	WOVEN POLYPROPYLENE
SECONDARY BACKING:	ACTIONBAC
PATTERN REPEAT (W x L):	NONE
FLAMMABILITY:	PASSES PILL TEST (CPSC FF1-70, ASTM D-2859)

*\*All specifications are approximate and are subject to normal manufacturing tolerances not to exceed industry standards.*

### SPECIAL FEATURES

- SO SOFT™ PET MANUFACTURED EXCLUSIVELY BY SOUTHWIND FLOORS FOR LIFE
- SOLUTION DYED FIBER FOR SUPERIOR FADE RESISTANCE AND INHERENT STAIN RESISTANCE
- ECO FRIENDLY — VIRTUALLY WATERLESS MANUFACTURING PROCESS
- CARPET AND RUG INSTITUTE GREEN LABEL PLUS INDOOR AIR QUALITY CERTIFIED
- PERMANENT STATIC CONTROL
- SOIL PROTECTION

### WARRANTIES

- LIFETIME LIMITED STAIN RESISTANCE
- LIFETIME LIMITED SOIL RESISTANCE
- LIFETIME LIMITED ANTI-STATIC
- 25 YEAR LIMITED ABRASIVE WEAR
- 25 YEAR LIMITED TEXTURE RETENTION
- 25 YEAR LIMITED FADE RESISTANCE
- 25 YEAR LIMITED PET URINE STAIN RESISTANCE

*For complete warranty details, go to [www.SouthwindFloors.com](http://www.SouthwindFloors.com)*



1401 Mirror Image    1402 Reflections    1403 Vista    1404 Stargazer    1405 Pixels    1406 Lunar



1407 Elements    1408 Planetary    1409 Sundance    1410 Visions    1411 Aura    1412 Synthesis

## MEDLEY A154



*A hybrid of the perfect blend of So Soft™ PET texture and color in a cut pile carpet, to create 8 subtle, organic universal hues.*

### PRODUCT SPECIFICATIONS\*

STYLE TYPE:	MULTICOLOR TEXTURED CUT PILE
FIBER:	100% CONTINUOUS FILAMENT SO SOFT™ PET
GAUGE:	1/10
WIDTH:	12 FT.
TUFTED YARN WEIGHT:	60 OZ. PER SQUARE YARD
PILE HEIGHT:	24/32"
DYEING PROCESS:	SOLUTION DYED
PRIMARY BACKING:	WOVEN POLYPROPYLENE
SECONDARY BACKING:	ACTIONBAC
PATTERN REPEAT (W x L):	NONE
FLAMMABILITY:	PASSES PILL TEST (CPSC FF1-70, ASTM D-2859)

*\*All specifications are approximate and are subject to normal manufacturing tolerances not to exceed industry standards.*

### SPECIAL FEATURES

- SO SOFT™ PET MANUFACTURED EXCLUSIVELY BY SOUTHWIND FLOORS FOR LIFE
- SOLUTION DYED FIBER FOR SUPERIOR FADE RESISTANCE AND INHERENT STAIN RESISTANCE
- ECO FRIENDLY — VIRTUALLY WATERLESS MANUFACTURING PROCESS
- CARPET AND RUG INSTITUTE GREEN LABEL PLUS INDOOR AIR QUALITY CERTIFIED
- PERMANENT STATIC CONTROL
- SOIL PROTECTION

### WARRANTIES

- LIFETIME LIMITED STAIN RESISTANCE
- LIFETIME LIMITED SOIL RESISTANCE
- LIFETIME LIMITED ANTI-STATIC
- 25 YEAR LIMITED ABRASIVE WEAR
- 25 YEAR LIMITED TEXTURE RETENTION
- 25 YEAR LIMITED FADE RESISTANCE
- 25 YEAR LIMITED PET URINE STAIN RESISTANCE

*For complete warranty details, go to [www.SouthwindFloors.com](http://www.SouthwindFloors.com)*



5401 Illusion    5402 Mystere    5403 Opulence    5404 Epic    5405 Ethereal



5406 Dreamland    5407 Hypnotic    5408 Showstopper

## MOSAIC A162

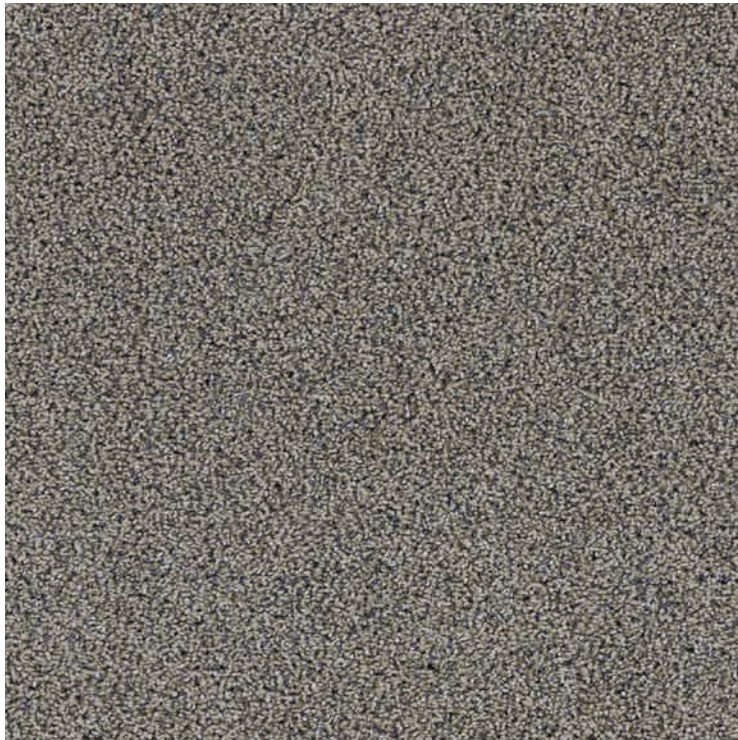

*Stylish Precision Cut and Un-cut carpet designed with So Soft™ solution-dyed PET in tonal and cross-color barber pole yarn combinations for a uniquely textural look. Available in 9 pleasing colorways.*

### PRODUCT SPECIFICATIONS\*

STYLE TYPE:	PRECISION CUT/UNCUT
FIBER:	100% CONTINUOUS FILAMENT SO SOFT™ PET
GAUGE:	1/8
WIDTH:	12 FT.
TUFTED YARN WEIGHT:	46 OZ. PER SQUARE YARD
PILE HEIGHT:	16/32" (CUT) 15/32" (LOOP)
DYEING PROCESS:	SOLUTION DYED
PRIMARY BACKING:	WOVEN POLYPROPYLENE
SECONDARY BACKING:	ACTIONBAC
PATTERN REPEAT (W X L):	NONE
FLAMMABILITY:	PASSES PILL TEST (CPSC FF1-70, ASTM D-2859)

*\*All specifications are approximate and are subject to normal manufacturing tolerances not to exceed industry standards.*

### SPECIAL FEATURES

- SO SOFT™ PET MANUFACTURED EXCLUSIVELY BY SOUTHWIND FLOORS FOR LIFE
- SOLUTION DYED FIBER FOR SUPERIOR FADE RESISTANCE AND INHERENT STAIN RESISTANCE
- ECO FRIENDLY — VIRTUALLY WATERLESS MANUFACTURING PROCESS
- CARPET AND RUG INSTITUTE GREEN LABEL PLUS INDOOR AIR QUALITY CERTIFIED
- PERMANENT STATIC CONTROL
- SOIL PROTECTION

### WARRANTIES

- LIFETIME LIMITED STAIN RESISTANCE
- LIFETIME LIMITED SOIL RESISTANCE
- LIFETIME LIMITED ANTI-STATIC
- 25 YEAR LIMITED ABRASIVE WEAR
- 25 YEAR LIMITED TEXTURE RETENTION
- 25 YEAR LIMITED FADE RESISTANCE
- 25 YEAR LIMITED PET URINE STAIN RESISTANCE

*For complete warranty details, go to [www.SouthwindFloors.com](http://www.SouthwindFloors.com)*



6201 Décor    6202 Digital    6203 Pebblestone    6204 Classical    6205 Artistry

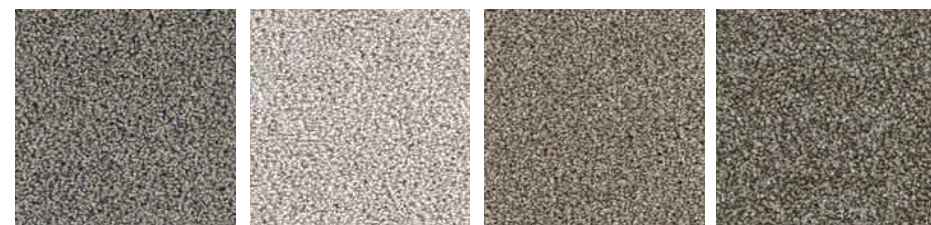

6206 Jewel    6207 Images    6208 Pixels    6209 Motif

## MYSTIC A116



*MYSTIC is the perfect blend of soft texture and soft color to create quiet glamour for the floor. Styled in 8 pleasing colorations.*

### PRODUCT SPECIFICATIONS\*

STYLE TYPE:	TONAL TEXTURED CUT PILE
FIBER:	100% CONTINUOUS FILAMENT SO SOFT™ PET
GAUGE:	1/8
WIDTH:	12 FT.
TUFTED YARN WEIGHT:	42 OZ. PER SQUARE YARD
PILE HEIGHT:	22/32"
DYEING PROCESS:	SOLUTION DYED
PRIMARY BACKING:	WOVEN POLYPROPYLENE
SECONDARY BACKING:	ACTIONBAC
PATTERN REPEAT (W X L):	NONE
FLAMMABILITY:	PASSES PILL TEST (CPSC FF1-70, ASTM D-2859)

*\*All specifications are approximate and are subject to normal manufacturing tolerances not to exceed industry standards.*

### SPECIAL FEATURES

- SO SOFT™ PET MANUFACTURED EXCLUSIVELY BY SOUTHWIND FLOORS FOR LIFE
- SOLUTION DYED FIBER FOR SUPERIOR FADE RESISTANCE AND INHERENT STAIN RESISTANCE
- ECO FRIENDLY — VIRTUALLY WATERLESS MANUFACTURING PROCESS
- CARPET AND RUG INSTITUTE GREEN LABEL PLUS INDOOR AIR QUALITY CERTIFIED
- PERMANENT STATIC CONTROL
- SOIL PROTECTION

### WARRANTIES

- LIFETIME LIMITED STAIN RESISTANCE
- LIFETIME LIMITED SOIL RESISTANCE
- LIFETIME LIMITED ANTI-STATIC
- 25 YEAR LIMITED ABRASIVE WEAR
- 25 YEAR LIMITED TEXTURE RETENTION
- 25 YEAR LIMITED FADE RESISTANCE
- 25 YEAR LIMITED PET URINE STAIN RESISTANCE

*For complete warranty details, go to [www.SouthwindFloors.com](http://www.SouthwindFloors.com)*



6001 Ethereal    6002 Artistic    6003 Illusion    6004 Mystery    6005 Expression



6006 Dreamland    6007 Imagine    6008 Magical

## NORTHERN LIGHTS A105



*This beauty is an unparalleled soft wonder and an exceptionally-styled vision of light reflection for the floor. It pairs cross-tones to blend and create 12 prismatic colorations of true visual harmony in a textural cut pile experience.*

### PRODUCT SPECIFICATIONS\*

STYLE TYPE:	MULTICOLOR TEXTURED CUT PILE
FIBER:	100% CONTINUOUS FILAMENT SO SOFT™ PET
GAUGE:	3/16
WIDTH:	12 FT.
TUFTED YARN WEIGHT:	50 OZ. PER SQUARE YARD
PILE HEIGHT:	24/32"
DYEING PROCESS:	SOLUTION DYED
PRIMARY BACKING:	WOVEN POLYPROPYLENE
SECONDARY BACKING:	ACTIONBAC
PATTERN REPEAT (W x L):	NONE
FLAMMABILITY:	PASSES PILL TEST (CPSC FF1-70, ASTM D-2859)

*\*All specifications are approximate and are subject to normal manufacturing tolerances not to exceed industry standards.*

### SPECIAL FEATURES

- SO SOFT™ PET MANUFACTURED EXCLUSIVELY BY SOUTHWIND FLOORS FOR LIFE
- SOLUTION DYED FIBER FOR SUPERIOR FADE RESISTANCE AND INHERENT STAIN RESISTANCE
- ECO FRIENDLY — VIRTUALLY WATERLESS MANUFACTURING PROCESS
- CARPET AND RUG INSTITUTE GREEN LABEL PLUS INDOOR AIR QUALITY CERTIFIED
- PERMANENT STATIC CONTROL
- SOIL PROTECTION

### WARRANTIES

- LIFETIME LIMITED STAIN RESISTANCE
- LIFETIME LIMITED SOIL RESISTANCE
- LIFETIME LIMITED ANTI-STATIC
- 25 YEAR LIMITED ABRASIVE WEAR
- 25 YEAR LIMITED TEXTURE RETENTION
- 25 YEAR LIMITED FADE RESISTANCE
- 25 YEAR LIMITED PET URINE STAIN RESISTANCE

*For complete warranty details, go to [www.SouthwindFloors.com](http://www.SouthwindFloors.com)*



1501 Wavelength    1502 Rhythm    1503 Flair    1504 Cosmos    1505 Digital    1506 Prisms



1507 Impressions    1508 Harmony    1509 Mosaic    1510 Images    1511 Magnetism    1512 Dazzling

## NUANCE A155



*This cut pile carpet offers a full hand of dense sophistication in 6 elegant color choices. Made of So Soft™ PET for winning fashion and elegant style.*

### PRODUCT SPECIFICATIONS\*

STYLE TYPE:	MULTICOLOR TEXTURED CUT PILE
FIBER:	100% CONTINUOUS FILAMENT SO SOFT™ PET
GAUGE:	1/10
WIDTH:	12 FT.
TUFTED YARN WEIGHT:	55 OZ. PER SQUARE YARD
PILE HEIGHT:	18/32"
DYEING PROCESS:	SOLUTION DYED
PRIMARY BACKING:	WOVEN POLYPROPYLENE
SECONDARY BACKING:	ACTIONBAC
PATTERN REPEAT (W x L):	NONE
FLAMMABILITY:	PASSES PILL TEST (CPSC FF1-70, ASTM D-2859)

*\*All specifications are approximate and are subject to normal manufacturing tolerances not to exceed industry standards.*

### SPECIAL FEATURES

- SO SOFT™ PET MANUFACTURED EXCLUSIVELY BY SOUTHWIND FLOORS FOR LIFE
- SOLUTION DYED FIBER FOR SUPERIOR FADE RESISTANCE AND INHERENT STAIN RESISTANCE
- ECO FRIENDLY — VIRTUALLY WATERLESS MANUFACTURING PROCESS
- CARPET AND RUG INSTITUTE GREEN LABEL PLUS INDOOR AIR QUALITY CERTIFIED
- PERMANENT STATIC CONTROL
- SOIL PROTECTION

### WARRANTIES

- LIFETIME LIMITED STAIN RESISTANCE
- LIFETIME LIMITED SOIL RESISTANCE
- LIFETIME LIMITED ANTI-STATIC
- 25 YEAR LIMITED ABRASIVE WEAR
- 25 YEAR LIMITED TEXTURE RETENTION
- 25 YEAR LIMITED FADE RESISTANCE
- 25 YEAR LIMITED PET URINE STAIN RESISTANCE

*For complete warranty details, go to [www.SouthwindFloors.com](http://www.SouthwindFloors.com)*



5501 Vapor    5502 Natural Touch    5503 Refined Taupe    5504 Misty    5505 Fog    5506 Granite

**OPTICS A113**



*OPTICS is 70 ounces of luxurious softness in a tight, dense cut pile carpet. Uniquely styled with tonal accents for subtle elegance in 8 colorations.*

**PRODUCT SPECIFICATIONS\***

STYLE TYPE:	TONAL TEXTURED CUT PILE
FIBER:	100% CONTINUOUS FILAMENT SO SOFT™ PET
GAUGE:	1/10
WIDTH:	12 FT.
TUFTED YARN WEIGHT:	70 OZ. PER SQUARE YARD
PILE HEIGHT:	24/32"
DYEING PROCESS:	SOLUTION DYED
PRIMARY BACKING:	WOVEN POLYPROPYLENE
SECONDARY BACKING:	ACTIONBAC
PATTERN REPEAT (W x L):	NONE
FLAMMABILITY:	PASSES PILL TEST (CPSC FF1-70, ASTM D-2859)

*\*All specifications are approximate and are subject to normal manufacturing tolerances not to exceed industry standards.*

**SPECIAL FEATURES**

- SO SOFT™ PET MANUFACTURED EXCLUSIVELY BY SOUTHWIND FLOORS FOR LIFE
- SOLUTION DYED FIBER FOR SUPERIOR FADE RESISTANCE AND INHERENT STAIN RESISTANCE
- ECO FRIENDLY — VIRTUALLY WATERLESS MANUFACTURING PROCESS
- CARPET AND RUG INSTITUTE GREEN LABEL PLUS INDOOR AIR QUALITY CERTIFIED
- PERMANENT STATIC CONTROL
- SOIL PROTECTION

**WARRANTIES**

- LIFETIME LIMITED STAIN RESISTANCE
- LIFETIME LIMITED SOIL RESISTANCE
- LIFETIME LIMITED ANTI-STATIC
- 25 YEAR LIMITED ABRASIVE WEAR
- 25 YEAR LIMITED TEXTURE RETENTION
- 25 YEAR LIMITED FADE RESISTANCE
- 25 YEAR LIMITED PET URINE STAIN RESISTANCE

*For complete warranty details, go to [www.SouthwindFloors.com](http://www.SouthwindFloors.com)*



3001 Illumination    3002 Light Dance    3003 Visionary    3004 Genesis    3005 Radiance



3006 Nova    3007 Power Source    3008 Intensity

**PARAMOUNT P250**

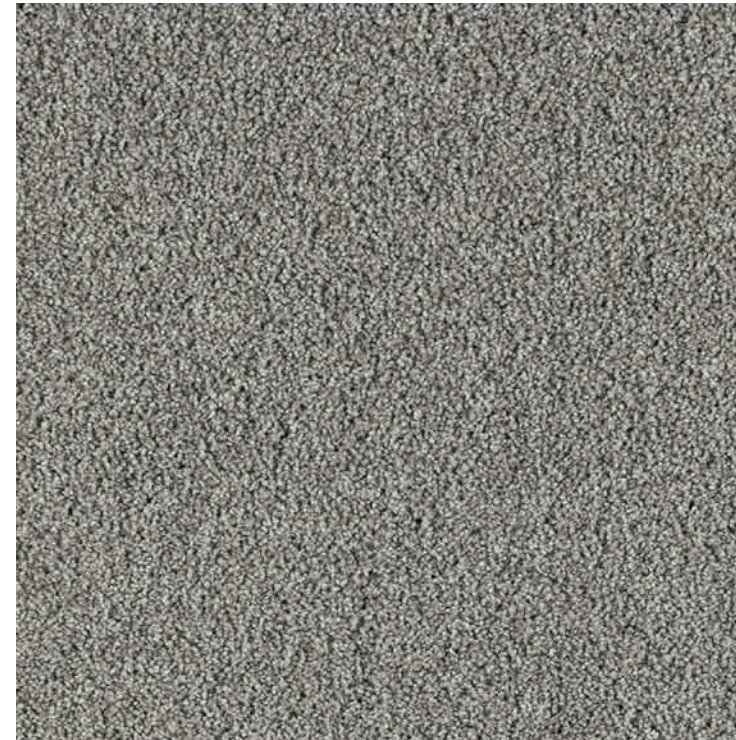

*This cut pile carpet was created in a perfectly smart combination of a very soft, smooth hand and 7 fashionable tone-on tone tweed colorations. Styled with So Soft™ solution dyed PET.*

**PRODUCT SPECIFICATIONS\***

STYLE TYPE:	TEXTURED CUT PILE
FIBER:	100% CONTINUOUS FILAMENT SO SOFT™ PET
GAUGE:	1/10
WIDTH:	12 FT.
PILE HEIGHT:	16/32"
DYEING PROCESS:	SOLUTION DYED
PRIMARY BACKING:	WOVEN POLYPROPYLENE
SECONDARY BACKING:	COMFORT BACK
PATTERN REPEAT (W x L):	NONE
FLAMMABILITY:	PASSES PILL TEST (CPSC FF1-70, ASTM D-2859)

*\*All specifications are approximate and are subject to normal manufacturing tolerances not to exceed industry standards.*

**SPECIAL FEATURES**

- SOLUTION DYED FIBER FOR SUPERIOR FADE RESISTANCE AND INHERENT STAIN RESISTANCE
- ECO FRIENDLY — VIRTUALLY WATERLESS MANUFACTURING PROCESS
- CARPET AND RUG INSTITUTE GREEN LABEL PLUS INDOOR AIR QUALITY CERTIFIED
- PERMANENT STATIC CONTROL
- SOIL PROTECTION

**WARRANTIES**

- LIFETIME LIMITED STAIN RESISTANCE
- LIFETIME LIMITED SOIL RESISTANCE
- LIFETIME LIMITED ANTI-STATIC
- 25 YEAR LIMITED ABRASIVE WEAR
- 25 YEAR LIMITED TEXTURE RETENTION
- 25 YEAR LIMITED FADE RESISTANCE
- 25 YEAR LIMITED PET URINE STAIN RESISTANCE

*For complete warranty details, go to [www.SouthwindFloors.com](http://www.SouthwindFloors.com)*



5001 Supreme Neutral    5002 Super Natural    5003 Highland    5004 First Watch

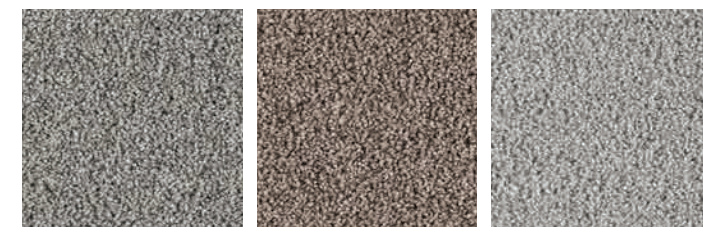

5005 Prime Gray    5006 Stony Peak    5007 Fine Mist



## PRINCETON L131



LCL (Level Cut and Loop) pattern in a subtle parquet block pattern created with solid and tonal yarns that is fabulous fashion for the floor. Available in 5 sophisticated colorations.

### PRODUCT SPECIFICATIONS\*

STYLE TYPE:	PATTERNED LEVEL CUT & LOOP
FIBER:	100% CONTINUOUS FILAMENT SO SOFT™ PET
GAUGE:	1/10
WIDTH:	12 FT.
TUFTED YARN WEIGHT:	36 OZ. PER SQUARE YARD
PILE HEIGHT:	12/32" (CUT) 8/32" (LOOP)
DYEING PROCESS:	SOLUTION DYED
PRIMARY BACKING:	WOVEN POLYPROPYLENE
SECONDARY BACKING:	ACTIONBAC
PATTERN REPEAT (W x L):	8" W x 8 1/2" L
FLAMMABILITY:	PASSES PILL TEST (CPSC FF1-70, ASTM D-2859)

*\*All specifications are approximate and are subject to normal manufacturing tolerances not to exceed industry standards.*

### SPECIAL FEATURES

- SO SOFT™ PET MANUFACTURED EXCLUSIVELY BY SOUTHWIND FLOORS FOR LIFE
- SOLUTION DYED FIBER FOR SUPERIOR FADE RESISTANCE AND INHERENT STAIN RESISTANCE
- ECO FRIENDLY — VIRTUALLY WATERLESS MANUFACTURING PROCESS
- CARPET AND RUG INSTITUTE GREEN LABEL PLUS INDOOR AIR QUALITY CERTIFIED
- SOIL PROTECTION

### WARRANTIES

- LIFETIME LIMITED STAIN RESISTANCE
- LIFETIME LIMITED SOIL RESISTANCE
- 25 YEAR LIMITED ABRASIVE WEAR
- 25 YEAR LIMITED TEXTURE RETENTION
- 25 YEAR LIMITED FADE RESISTANCE
- 25 YEAR LIMITED PET URINE STAIN RESISTANCE

*For complete warranty details, go to [www.SouthwindFloors.com](http://www.SouthwindFloors.com)*

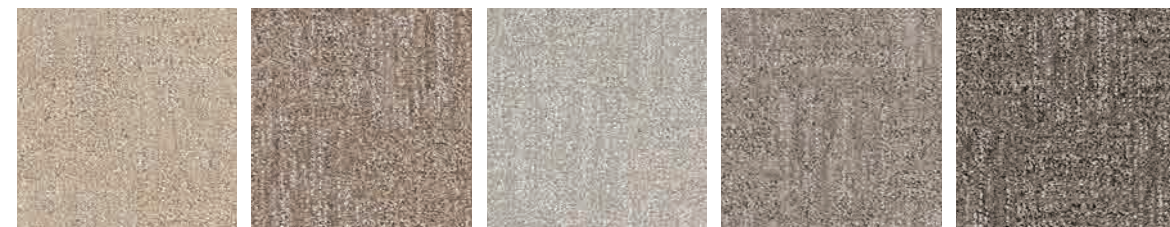

3305 Tweedy    3306 Icon    3307 Felt    3308 Flannel    3309 Batik

## PRISMS A114



PRISMS is truly a tactile and visual experience with 70 ounces of unmatched beauty and softness. 8 cross-tones of neutral color pair to create fashionable sophistication.

### PRODUCT SPECIFICATIONS\*

STYLE TYPE:	MULTICOLOR TEXTURED CUT PILE
FIBER:	100% CONTINUOUS FILAMENT SO SOFT™ PET
GAUGE:	3/16
WIDTH:	12 FT.
TUFTED YARN WEIGHT:	70 OZ. PER SQUARE YARD
PILE HEIGHT:	27/32"
DYEING PROCESS:	SOLUTION DYED
PRIMARY BACKING:	WOVEN POLYPROPYLENE
SECONDARY BACKING:	ACTIONBAC
PATTERN REPEAT (W x L):	NONE
FLAMMABILITY:	PASSES PILL TEST (CPSC FF1-70, ASTM D-2859)

*\*All specifications are approximate and are subject to normal manufacturing tolerances not to exceed industry standards.*

### SPECIAL FEATURES

- SO SOFT™ PET MANUFACTURED EXCLUSIVELY BY SOUTHWIND FLOORS FOR LIFE
- SOLUTION DYED FIBER FOR SUPERIOR FADE RESISTANCE AND INHERENT STAIN RESISTANCE
- ECO FRIENDLY — VIRTUALLY WATERLESS MANUFACTURING PROCESS
- CARPET AND RUG INSTITUTE GREEN LABEL PLUS INDOOR AIR QUALITY CERTIFIED
- PERMANENT STATIC CONTROL
- SOIL PROTECTION

### WARRANTIES

- LIFETIME LIMITED STAIN RESISTANCE
- LIFETIME LIMITED SOIL RESISTANCE
- LIFETIME LIMITED ANTI-STATIC
- 25 YEAR LIMITED ABRASIVE WEAR
- 25 YEAR LIMITED TEXTURE RETENTION
- 25 YEAR LIMITED FADE RESISTANCE
- 25 YEAR LIMITED PET URINE STAIN RESISTANCE

*For complete warranty details, go to [www.SouthwindFloors.com](http://www.SouthwindFloors.com)*



4001 Light Beam    4002 Facets    4003 Spectrum    4004 Refraction    4005 Crystal Glow

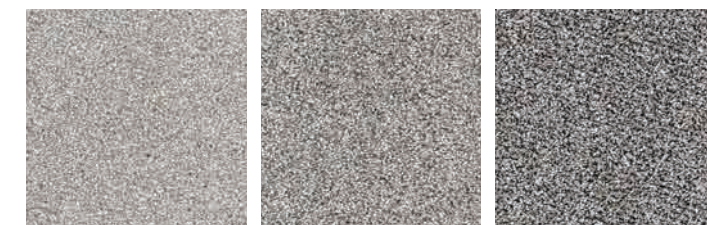

4006 Quartz    4007 Gravity    4008 Night Vision

**PURE LUXURY A156**



The name says it all—this is 80 ounces of pure luxury, made in a dense cut pile carpet of So Soft™ PET for softness and elegance that are unsurpassed, in a palette of 8 glamorous colorations.

**PRODUCT SPECIFICATIONS\***

STYLE TYPE:	MULTICOLOR TEXTURED CUT PILE
FIBER:	100% CONTINUOUS FILAMENT SO SOFT™ PET
GAUGE:	3/16
WIDTH:	12 FT.
TUFTED YARN WEIGHT:	80 OZ. PER SQUARE YARD
PILE HEIGHT:	27/32"
DYEING PROCESS:	SOLUTION DYED
PRIMARY BACKING:	WOVEN POLYPROPYLENE
SECONDARY BACKING:	ACTIONBAC
PATTERN REPEAT (W X L):	NONE
FLAMMABILITY:	PASSES PILL TEST (CPSC FF1-70, ASTM D-2859)

*\*All specifications are approximate and are subject to normal manufacturing tolerances not to exceed industry standards.*

**SPECIAL FEATURES**

- SO SOFT™ PET MANUFACTURED EXCLUSIVELY BY SOUTHWIND FLOORS FOR LIFE
- SOLUTION DYED FIBER FOR SUPERIOR FADE RESISTANCE AND INHERENT STAIN RESISTANCE
- ECO FRIENDLY — VIRTUALLY WATERLESS MANUFACTURING PROCESS
- CARPET AND RUG INSTITUTE GREEN LABEL PLUS INDOOR AIR QUALITY CERTIFIED
- PERMANENT STATIC CONTROL
- SOIL PROTECTION

**WARRANTIES**

- LIFETIME LIMITED STAIN RESISTANCE
- LIFETIME LIMITED SOIL RESISTANCE
- LIFETIME LIMITED ANTI-STATIC
- 25 YEAR LIMITED ABRASIVE WEAR
- 25 YEAR LIMITED TEXTURE RETENTION
- 25 YEAR LIMITED FADE RESISTANCE
- 25 YEAR LIMITED PET URINE STAIN RESISTANCE

*For complete warranty details, go to [www.SouthwindFloors.com](http://www.SouthwindFloors.com)*



**RADIANT BEAUTY A103**



This cut pile textured carpet is a soft and beautiful luxurious experience. Its name truly speaks for itself in 15 “radiant” solid shades.

**PRODUCT SPECIFICATIONS\***

STYLE TYPE:	TEXTURED CUT PILE
FIBER:	100% CONTINUOUS FILAMENT SO SOFT™ PET
GAUGE:	3/16
WIDTH:	12 FT.
TUFTED YARN WEIGHT:	50 OZ. PER SQUARE YARD
PILE HEIGHT:	24/32"
DYEING PROCESS:	SOLUTION DYED
PRIMARY BACKING:	WOVEN POLYPROPYLENE
SECONDARY BACKING:	ACTIONBAC
PATTERN REPEAT (W x L):	NONE
FLAMMABILITY:	PASSES PILL TEST (CPSC FF1-70, ASTM D-2859)

*\*All specifications are approximate and are subject to normal manufacturing tolerances not to exceed industry standards.*

**SPECIAL FEATURES**

- SO SOFT™ PET MANUFACTURED EXCLUSIVELY BY SOUTHWIND FLOORS FOR LIFE
- SOLUTION DYED FIBER FOR SUPERIOR FADE RESISTANCE AND INHERENT STAIN RESISTANCE
- ECO FRIENDLY — VIRTUALLY WATERLESS MANUFACTURING PROCESS
- CARPET AND RUG INSTITUTE GREEN LABEL PLUS INDOOR AIR QUALITY CERTIFIED
- PERMANENT STATIC CONTROL
- SOIL PROTECTION

**WARRANTIES**

- LIFETIME LIMITED STAIN RESISTANCE
- LIFETIME LIMITED SOIL RESISTANCE
- LIFETIME LIMITED ANTI-STATIC
- 25 YEAR LIMITED ABRASIVE WEAR
- 25 YEAR LIMITED TEXTURE RETENTION
- 25 YEAR LIMITED FADE RESISTANCE
- 25 YEAR LIMITED PET URINE STAIN RESISTANCE

*For complete warranty details, go to [www.SouthwindFloors.com](http://www.SouthwindFloors.com)*



## SOUTHERN LIGHTS A151



Another winning addition to the popular Aurora Collection, this tonal cut pile carpet is constructed of So Soft™ PET for comfort and value in 8 variegated colorations.

### PRODUCT SPECIFICATIONS\*

STYLE TYPE:	MULTICOLOR TEXTURED CUT PILE
FIBER:	100% CONTINUOUS FILAMENT SO SOFT™ PET
GAUGE:	3/16
WIDTH:	12 FT.
TUFTED YARN WEIGHT:	40 OZ. PER SQUARE YARD
PILE HEIGHT:	21/32"
DYEING PROCESS:	SOLUTION DYED
PRIMARY BACKING:	WOVEN POLYPROPYLENE
SECONDARY BACKING:	ACTIONBAC
PATTERN REPEAT (W X L):	NONE
FLAMMABILITY:	PASSES PILL TEST (CPSC FF1-70, ASTM D-2859)

*\*All specifications are approximate and are subject to normal manufacturing tolerances not to exceed industry standards.*

### SPECIAL FEATURES

- SO SOFT™ PET MANUFACTURED EXCLUSIVELY BY SOUTHWIND FLOORS FOR LIFE
- SOLUTION DYED FIBER FOR SUPERIOR FADE RESISTANCE AND INHERENT STAIN RESISTANCE
- ECO FRIENDLY — VIRTUALLY WATERLESS MANUFACTURING PROCESS
- CARPET AND RUG INSTITUTE GREEN LABEL PLUS INDOOR AIR QUALITY CERTIFIED
- PERMANENT STATIC CONTROL
- SOIL PROTECTION

### WARRANTIES

- LIFETIME LIMITED STAIN RESISTANCE
- LIFETIME LIMITED SOIL RESISTANCE
- LIFETIME LIMITED ANTI-STATIC
- 25 YEAR LIMITED ABRASIVE WEAR
- 25 YEAR LIMITED TEXTURE RETENTION
- 25 YEAR LIMITED FADE RESISTANCE
- 25 YEAR LIMITED PET URINE STAIN RESISTANCE

*For complete warranty details, go to [www.SouthwindFloors.com](http://www.SouthwindFloors.com)*



5101 Daybreak    5102 Natural Wonder    5103 Sunset    5104 Western Glow    5105 Lightning Flash



5106 Equator    5107 Dusk    5108 Equinox

## STARLIGHT II S252

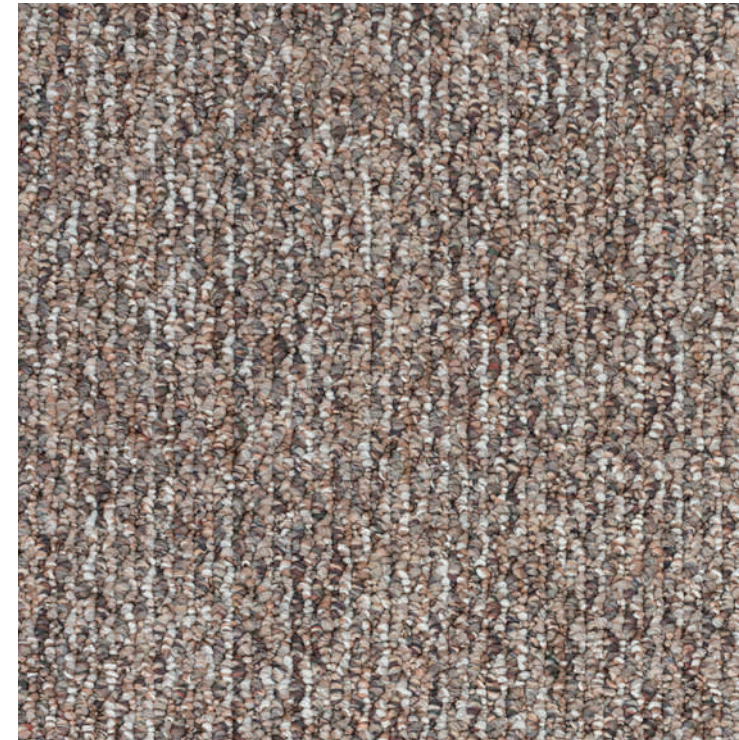

This is our flagship berber-look carpet, styled in a classic textural loop construction. Each color is designed with combinations of tonal or cross-color yarns to look smart in any style of décor. Available in 9 timeless colorations.

### PRODUCT SPECIFICATIONS\*

STYLE TYPE:	SCROLL LOOP BERBER
FIBER:	100% BCF SD-XTRA® POLYPROPYLENE
GAUGE:	3/16
WIDTH:	12 FT. & 15 FT.
TUFTED YARN WEIGHT:	20.5 OZ. PER SQUARE YARD
PILE HEIGHT:	21/64" (HIGH) 9/64" (LOW)
DYEING PROCESS:	SOLUTION DYED
PRIMARY BACKING:	WOVEN POLYPROPYLENE
SECONDARY BACKING:	ACTIONBAC
PATTERN REPEAT (W X L):	3/4" W X 1" L
FLAMMABILITY:	PASSES PILL TEST (CPSC FF1-70, ASTM D-2859)

*\*All specifications are approximate and are subject to normal manufacturing tolerances not to exceed industry standards.*

### SPECIAL FEATURES

- SD-XTRA® POLYPROPYLENE — SOLUTION DYED FIBER FOR SUPERIOR FADE RESISTANCE AND INHERENT STAIN RESISTANCE
- ECO FRIENDLY — VIRTUALLY WATERLESS MANUFACTURING PROCESS
- CARPET AND RUG INSTITUTE GREEN LABEL PLUS INDOOR AIR QUALITY CERTIFIED
- PERMANENT STATIC CONTROL

### WARRANTIES

- 10 YEAR LIMITED WEAR
- 10 YEAR LIMITED STAIN

*For complete warranty details, go to [www.southwindfloors.com](http://www.southwindfloors.com)*



5208 Earthenware    5209 Bravado    5213 Timberlake    5224 Landscape    5231 Stellar    5232 Urban Mix

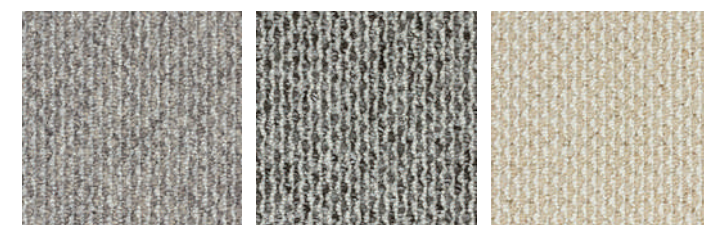

5233 Marble    5234 Eclipse    5235 Day Glow

## STELLAR A118



*STELLAR is a solid foundation with timeless beauty and soft elegance. Styled with 12 versatile colors including fashionable blue and green hues.*

### PRODUCT SPECIFICATIONS\*

STYLE TYPE:	SOLID TEXTURED CUT PILE
FIBER:	100% CONTINUOUS FILAMENT SO SOFT™ PET
GAUGE:	3/16
WIDTH:	12 FT.
TUFTED YARN WEIGHT:	42 OZ. PER SQUARE YARD
PILE HEIGHT:	22/32"
DYEING PROCESS:	SOLUTION DYED
PRIMARY BACKING:	WOVEN POLYPROPYLENE
SECONDARY BACKING:	ACTIONBAC
PATTERN REPEAT (W x L):	NONE
FLAMMABILITY:	PASSES PILL TEST (CPSC FF1-70, ASTM D-2859)

*\*All specifications are approximate and are subject to normal manufacturing tolerances not to exceed industry standards.*

### SPECIAL FEATURES

- SO SOFT™ PET MANUFACTURED EXCLUSIVELY BY SOUTHWIND FLOORS FOR LIFE
- SOLUTION DYED FIBER FOR SUPERIOR FADE RESISTANCE AND INHERENT STAIN RESISTANCE
- ECO FRIENDLY — VIRTUALLY WATERLESS MANUFACTURING PROCESS
- CARPET AND RUG INSTITUTE GREEN LABEL PLUS INDOOR AIR QUALITY CERTIFIED
- PERMANENT STATIC CONTROL
- SOIL PROTECTION

### WARRANTIES

- LIFETIME LIMITED STAIN RESISTANCE
- LIFETIME LIMITED SOIL RESISTANCE
- LIFETIME LIMITED ANTI-STATIC
- 25 YEAR LIMITED ABRASIVE WEAR
- 25 YEAR LIMITED TEXTURE RETENTION
- 25 YEAR LIMITED FADE RESISTANCE
- 25 YEAR LIMITED PET URINE STAIN RESISTANCE

*For complete warranty details, go to [www.SouthwindFloors.com](http://www.SouthwindFloors.com)*

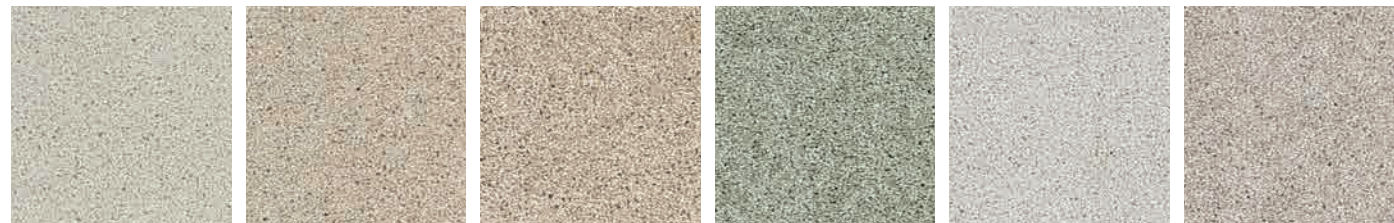

8001 Lunar Ray    8002 Orbit    8003 Energy    8004 Nebula    8005 Skylight    8006 Mineral

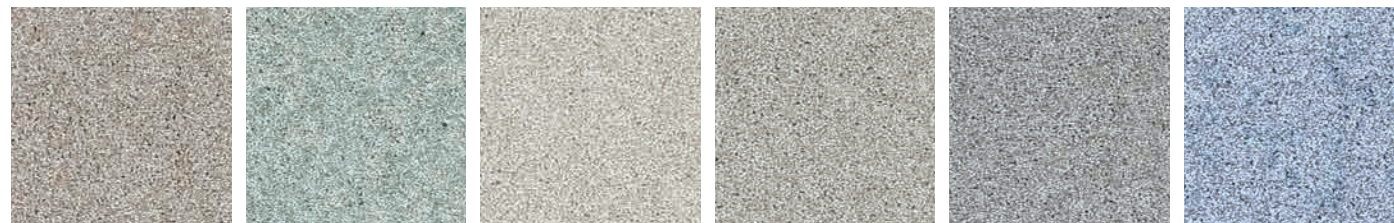

8007 Moon Rock    8008 Zenith    8009 Star Power    8010 Astronomy    8011 Milky Way    8012 Neptune

## STRATFORD L123



*LCL (Level Cut and Loop) styled in a smart, small-scaled "cobblestone" pattern for a wide range of uses. Available in 5 fashionable solid colors.*

### PRODUCT SPECIFICATIONS\*

STYLE TYPE:	PATTERNED LEVEL CUT & LOOP
FIBER:	100% CONTINUOUS FILAMENT SO SOFT™ PET
GAUGE:	1/10
WIDTH:	12 FT.
TUFTED YARN WEIGHT:	36 OZ. PER SQUARE YARD
PILE HEIGHT:	12/32" (CUT) 8/32" (LOOP)
DYEING PROCESS:	SOLUTION DYED
PRIMARY BACKING:	WOVEN POLYPROPYLENE
SECONDARY BACKING:	ACTIONBAC
PATTERN REPEAT (W x L):	20 1/4" W x 8 3/4" L
FLAMMABILITY:	PASSES PILL TEST (CPSC FF1-70, ASTM D-2859)

*\*All specifications are approximate and are subject to normal manufacturing tolerances not to exceed industry standards.*

### SPECIAL FEATURES

- SO SOFT™ PET MANUFACTURED EXCLUSIVELY BY SOUTHWIND FLOORS FOR LIFE
- SOLUTION DYED FIBER FOR SUPERIOR FADE RESISTANCE AND INHERENT STAIN RESISTANCE
- ECO FRIENDLY — VIRTUALLY WATERLESS MANUFACTURING PROCESS
- CARPET AND RUG INSTITUTE GREEN LABEL PLUS INDOOR AIR QUALITY CERTIFIED
- SOIL PROTECTION

### WARRANTIES

- LIFETIME LIMITED STAIN RESISTANCE
- LIFETIME LIMITED SOIL RESISTANCE
- 25 YEAR LIMITED ABRASIVE WEAR
- 25 YEAR LIMITED TEXTURE RETENTION
- 25 YEAR LIMITED FADE RESISTANCE
- 25 YEAR LIMITED PET URINE STAIN RESISTANCE

*For complete warranty details, go to [www.SouthwindFloors.com](http://www.SouthwindFloors.com)*

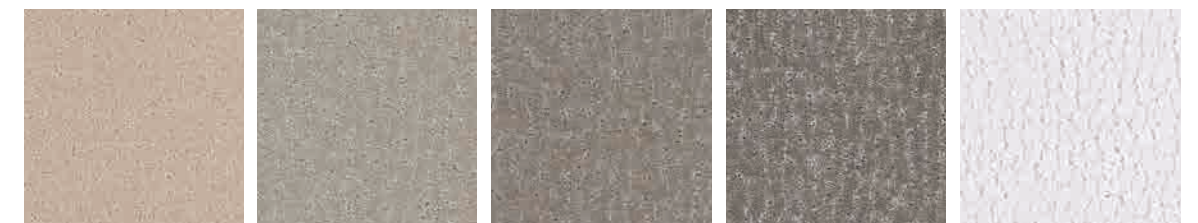

2305 Morning Fog    2309 Hammered Tin    2310 Pewter    2311 Slate    2313 Cotton

**WINDSOR COURT L122**



LCL (Level Cut and Loop) in a striking offset geometric pattern, designed for multiple applications. Available in 5 solid, on-trend colors.

**PRODUCT SPECIFICATIONS\***

STYLE TYPE:	PATTERNED LEVEL CUT & LOOP
FIBER:	100% CONTINUOUS FILAMENT SO SOFT™ PET
GAUGE:	1/10
WIDTH:	12 FT.
TUFTED YARN WEIGHT:	36 OZ. PER SQUARE YARD
PILE HEIGHT:	12/32" (CUT) 8/32" (LOOP)
DYEING PROCESS:	SOLUTION DYED
PRIMARY BACKING:	WOVEN POLYPROPYLENE
SECONDARY BACKING:	ACTIONBAC
PATTERN REPEAT (W x L):	18 1/4" W x 18 1/2" L
FLAMMABILITY:	PASSES PILL TEST (CPSC FF1-70, ASTM D-2859)

*\*All specifications are approximate and are subject to normal manufacturing tolerances not to exceed industry standards.*

**SPECIAL FEATURES**

- SO SOFT™ PET MANUFACTURED EXCLUSIVELY BY SOUTHWIND FLOORS FOR LIFE
- SOLUTION DYED FIBER FOR SUPERIOR FADE RESISTANCE AND INHERENT STAIN RESISTANCE
- ECO FRIENDLY — VIRTUALLY WATERLESS MANUFACTURING PROCESS
- CARPET AND RUG INSTITUTE GREEN LABEL PLUS INDOOR AIR QUALITY CERTIFIED
- SOIL PROTECTION

**WARRANTIES**

- LIFETIME LIMITED STAIN RESISTANCE
- LIFETIME LIMITED SOIL RESISTANCE
- 25 YEAR LIMITED ABRASIVE WEAR
- 25 YEAR LIMITED TEXTURE RETENTION
- 25 YEAR LIMITED FADE RESISTANCE
- 25 YEAR LIMITED PET URINE STAIN RESISTANCE

*For complete warranty details, go to [www.SouthwindFloors.com](http://www.SouthwindFloors.com)*



2205 Monterey    2209 Winter Frost    2210 Stonington    2211 Shadow    2213 Drifted Snow

**WINGATE L132**



LCL (Level Cut and Loop) in a stylish random pattern created by layers of loop and cut and tone-on-tone color placement. Available in 5 textural colorways.

**PRODUCT SPECIFICATIONS\***

STYLE TYPE:	PATTERNED LEVEL CUT & LOOP
FIBER:	100% CONTINUOUS FILAMENT SO SOFT™ PET
GAUGE:	1/10
WIDTH:	12 FT.
TUFTED YARN WEIGHT:	36 OZ. PER SQUARE YARD
PILE HEIGHT:	12/32" (CUT) 8/32" (LOOP)
DYEING PROCESS:	SOLUTION DYED
PRIMARY BACKING:	WOVEN POLYPROPYLENE
SECONDARY BACKING:	ACTIONBAC
PATTERN REPEAT (W x L):	9 1/2" W x 27 1/2" L
FLAMMABILITY:	PASSES PILL TEST (CPSC FF1-70, ASTM D-2859)

*\*All specifications are approximate and are subject to normal manufacturing tolerances not to exceed industry standards.*

**SPECIAL FEATURES**

- SO SOFT™ PET MANUFACTURED EXCLUSIVELY BY SOUTHWIND FLOORS FOR LIFE
- SOLUTION DYED FIBER FOR SUPERIOR FADE RESISTANCE AND INHERENT STAIN RESISTANCE
- ECO FRIENDLY — VIRTUALLY WATERLESS MANUFACTURING PROCESS
- CARPET AND RUG INSTITUTE GREEN LABEL PLUS INDOOR AIR QUALITY CERTIFIED
- SOIL PROTECTION

**WARRANTIES**

- LIFETIME LIMITED STAIN RESISTANCE
- LIFETIME LIMITED SOIL RESISTANCE
- 25 YEAR LIMITED ABRASIVE WEAR
- 25 YEAR LIMITED TEXTURE RETENTION
- 25 YEAR LIMITED FADE RESISTANCE
- 25 YEAR LIMITED PET URINE STAIN RESISTANCE

*For complete warranty details, go to [www.SouthwindFloors.com](http://www.SouthwindFloors.com)*



3201 Resort    3207 Tinsmith    3208 Concrete    3205 Manor    3206 Chateau



## SOUTHWIND WIDE FIVE SHELF CLOSET

Our curated collection of closet modules was selected to make customization and organization simple. The five shelf closet provides ample space for clothing and basket storage.

- Available in White and Walnut
- The shelves can be moved to any position, creating flexibility for storage on each shelf
- Product Dimensions: 30" wide x 84" tall
- Available in 15" and 24" depths

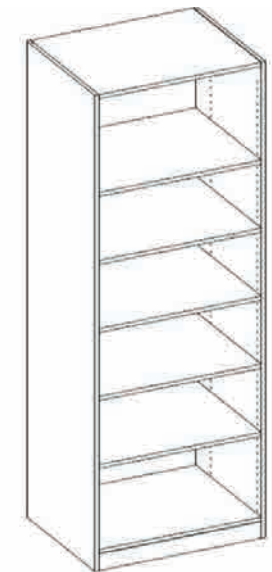

Southwind Wide Five Shelf Closet			
STYLE #	DESCRIPTION	COLOR #	SIZE CODE
5SHEL	5 SHELF CLOSET 30 X 15	WHITE	30X15
5SHEL	5 SHELF CLOSET 30 X 15	WALNU	30X15
5SHEL	5 SHELF CLOSET 30 X 24	WHITE	30X24
5SHEL	5 SHELF CLOSET 30 X 24	WALNU	30X24



## SOUTHWIND PETITE FIVE SHELF CLOSET

Southwind's 15" wide shelving unit packs a lot of storage in a small space. Utilize the flat shelves for sweaters, handbags or basket storage. These flexible pieces pair well with Southwind's shoe rack shelving, dual hanging closets and five drawer closets to provide a versatile solution for all of your storage needs.

- Available in White and Walnut
- Closet shelves can be moved to various positions, creating flexible storage space
- Add the Southwind Shoe Rack Accessory to customize even further
- Product Dimensions: 15" wide x 84" tall
- Available in 15" and 24" depths

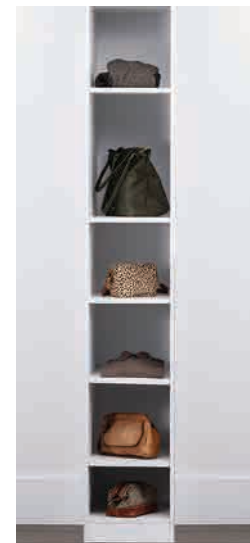

### Southwind Petite Five Shelf Closet

STYLE #	DESCRIPTION	COLOR #	SIZE CODE
5SHEL	5 SHELF CLOSET 15 X 15	WHITE	15X15
5SHEL	5 SHELF CLOSET 15 X 15	WALNU	15X15
5SHEL	5 SHELF CLOSET 15 X 24	WHITE	15X24
5SHEL	5 SHELF CLOSET 15 X 24	WALNU	15X24

## SOUTHWIND DUAL HANGING CLOSET

Stay sharp and organized with Southwind's dual hanging closet. Providing ample storage for all of your hanging garments, the Dual Hanging closet can also be assembled with just a single rod to accommodate your longer garments such as coats or dresswear.

- Available in White and Walnut
- The hanging closet can be assembled with dual hanging rods for shirts & pants, or a single rod for longer items such as coats or dresswear
- Product Dimensions: 30" wide x 84" tall
- Available in 15" and 24" depths

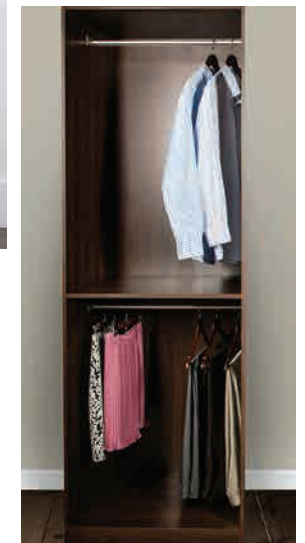
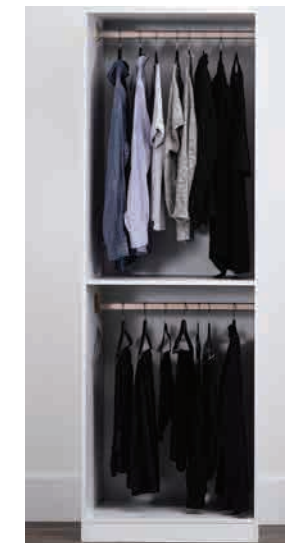

### Southwind Dual Hanging Closet

STYLE #	DESCRIPTION	COLOR #	SIZE CODE
HANCL	DUAL HANGING CLOSET	WHITE	30X15
HANCL	DUAL HANGING CLOSET	WALNU	30X15
HANCL	DUAL HANGING CLOSET	WHITE	30X24
HANCL	DUAL HANGING CLOSET	WALNU	30X24



## SOUTHWIND CORNER CLOSET

Southwind's Corner Closet unit is the perfect solution to transform wasted space into extra storage. The corner unit makes a seamless transition from one wall to the next for a truly custom look.

- Available in White and Walnut
- Only available in 15" depth
- Product dimensions 30" W (L&R) x 84" H

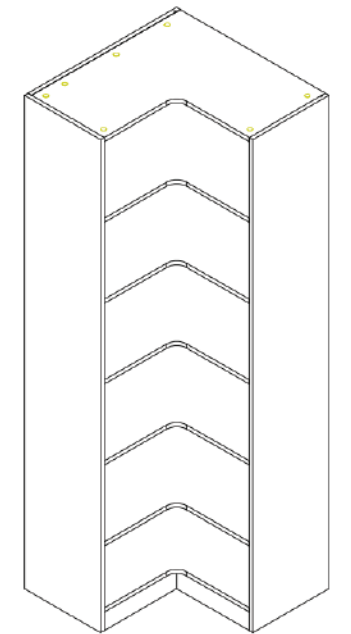

## SOUTHWIND FIVE DRAWER CLOSET

Southwind's Five Drawer closet organizer is the perfect storage solution. It combines the convenience of hanging storage with 5 drawers for folded items. All drawers come equipped with soft close glides.

- Available in White and Walnut
- Add the Southwind Closets Jewelry Accessory for a custom look
- Hardware Included
- Product Dimensions: 30" wide x 84" tall
- Available in 15" and 24" depths

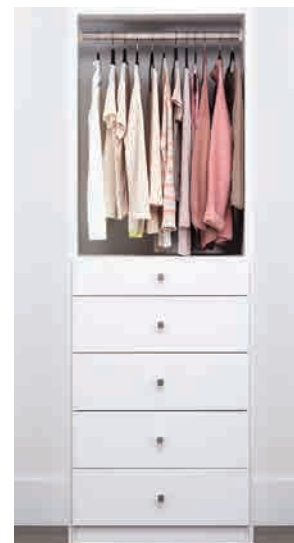

Southwind Five Drawer Closet			
STYLE #	DESCRIPTION	COLOR #	SIZE CODE
5DRAW	5 DRAWER CLOSET 30 X 15	WHITE	30X15
5DRAW	5 DRAWER CLOSET 30 X 15	WALNU	30X15
5DRAW	5 DRAWER CLOSET 30 X 24	WHITE	30X24
5DRAW	5 DRAWER CLOSET 30 X 24	WALNU	30X24

Southwind Corner Closet			
STYLE #	DESCRIPTION	COLOR #	SIZE CODE
CORCL	CORNER CLOSET	WHITE	30X15
CORCL	CORNER CLOSET	WALNU	30X15



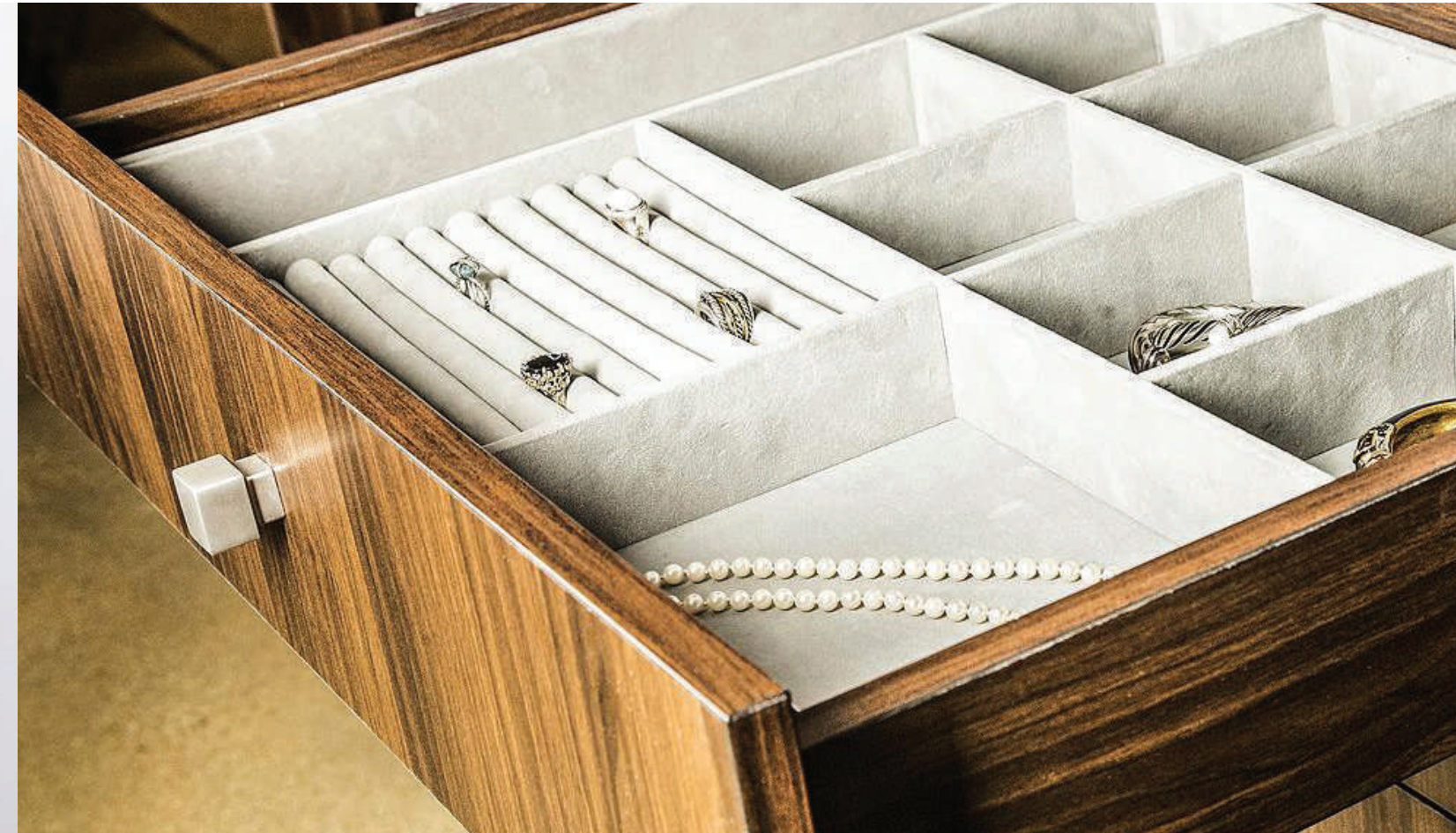

## SOUTHWIND SHOE RACK SHELVES

Showcase your footwear collection with Southwind angled shoe shelving. These shelves are a supplementary addition to the Southwind Petite Five Shelf Closet.

- Available in White and Walnut
- Brushed Nickel Front Detailing
- Available in 15" and 24" depths



Southwind Shoe Rack Shelves			
PRODUCT	DESCRIPTION	COLOR #	FINISH
SHRAC	SHOE RACK 6-SH 15 X 24	WHITE	15X24
SHRAC	SHOE RACK 6-SH 15 X 24	WALNU	15X24
SHRAC	SHOE RACK 6-SH 30 X 15	WHITE	30X15
SHRAC	SHOE RACK 6-SH 30 X 15	WALNU	30X15

## SOUTHWIND JEWELRY DIVIDER

The Southwind jewelry divider is designed to maximize organization and safe storage of your valuables.

- Includes: Small, Medium and Large Dividers, and Ring Holder
- Color: Light Grey
- Accessory item: Designed to Fit Five Drawer Closets and 30" Wide Drawer Bases
- Unit Weight: 7.7 lbs.
- Available in 15" and 24" depths



Southwind Jewelry Divider			
STYLE #	DESCRIPTION	COLOR #	SIZE CODE
JEWDR	JEWELRY DRAW. 30 X 24	GREY	30X24
JEWDR	JEWELRY DRAW. 30 X 15	GREY	30X15

## SOUTHWIND 2 DRAWER CLOSET CABINETS

Southwind's 2 drawer closet cabinets provide additional flexibility and options to customize your closet. Pair with other 3 drawer or 2 drawer cabinets and add a countertop to create a custom island or vanity. Now available in both 15" and 18" wide options.

- Available in White and Walnut
- Available in 24" depth

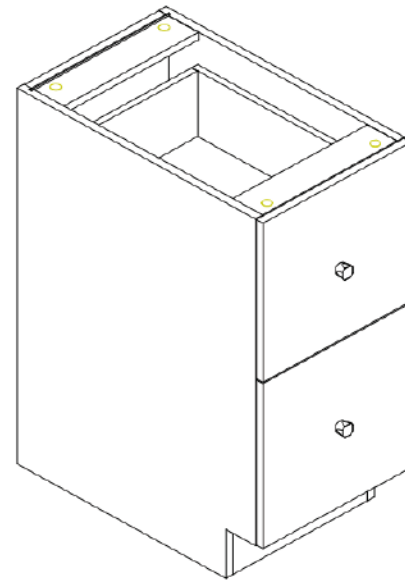

Southwind 2 Drawer Closet Cabinets			
STYLE #	DESCRIPTION	COLOR #	SIZE CODE
2DRAW	BASE 2 DRAW. 15 X 24 X 34	WHBAS	15X34
2DRAW	BASE 2 DRAW. 15 X 24 X 34	WABAS	15X34
2DRAW	BASE 2 DRAW. 18 X 24 X 34	WHBAS	18X34
2DRAW	BASE 2 DRAW. 18 X 24 X 34	WABAS	18X34

## SOUTHWIND 3 DRAWER CLOSET CABINETS

Southwind's 3 drawer closet cabinets provide additional flexibility and options to customize your closet. Pair with other 3 drawer or 2 drawer cabinets and add a countertop to create a custom island or vanity. Now available in both 24" and 30" wide options.

- Available in White and Walnut
- Available in 24" depth

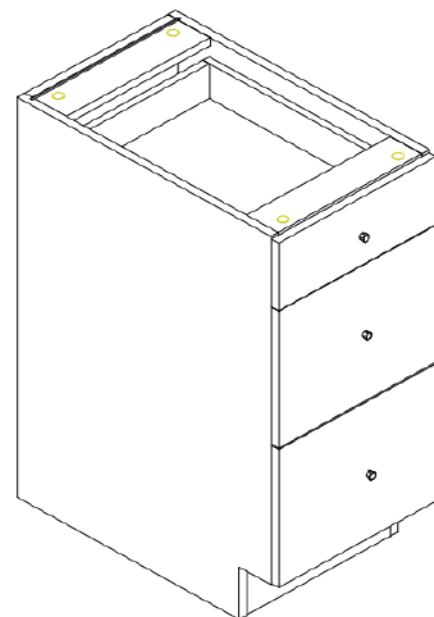

Southwind 3 Drawer Closet Cabinets			
STYLE #	DESCRIPTION	COLOR #	SIZE CODE
3DRAW	BASE 3 DRAW. 24 X 24 X 34	WHBAS	24X34
3DRAW	BASE 3 DRAW. 24 X 24 X 34	WABAS	24X34
3DRAW	BASE 3 DRAW. 30 X 24 X 34	WHBAS	30X34
3DRAW	BASE 3 DRAW. 30 X 24 X 34	WABAS	30X34

## SOUTHWIND DECORATIVE MOLDINGS

- Available in Walnut and White

Southwind Decorative Moldings				
STYLE #	DESCRIPTION	COLOR #	SIZE CODE	DIMENSIONS
CBAEP	END PANEL 3/4 X 34 1/2	WALNU	3/4X34	34.5" H x 24" D x 3/4" W
CBAEP	END PANEL 3/4 X 34 1/2	WHITE	3/4X34	34.5" H x 24" D x 3/4" W
CLCRM	CLASSIC CROWN 2-3/8 X 8	WALNU	2X8	8' H x 2 7/8" D x 2 3/8" W
CLCRM	CLASSIC CROWN 2-3/8 X 8	WHITE	2X8	8' H x 2 7/8" D x 2 3/8" W
CLISM	CLOSET ISLAND MOLDING	WALNU	3/4X8'	8' H x 3/4" D x 3/4" W
CLISM	CLOSET ISLAND MOLDING	WHITE	3/4X8'	8' H x 3/4" D x 3/4" W
CLISP	CLOSET ISLAND PANEL	WALNU	60X34	34 1/2" H x 3/16" D x 60" W
CLISP	CLOSET ISLAND PANEL	WHITE	60X34	34 1/2" H x 3/16" D x 60" W
CLQTR	CLOSET QUARTER ROUND	WALNU	3/4X8	8' H x 3/4" D x 3/4" W
CLQTR	CLOSET QUARTER ROUND	WHITE	3/4X8	8' H x 3/4" D x 3/4" W
CLSCM	CLOSET SCRIBE MOLDING	WALNU	3/4X8	8' H x 1/4" D x 3/4" W
CLSCM	CLOSET SCRIBE MOLDING	WHITE	3/4X8	8' H x 1/4" D x 3/4" W
CLWAF	CLOSET WALL FILL 3 X 96	WALNU	3X8	8' H x 1/2" D x 3" W
CLWAF	CLOSET WALL FILL 3 X 96	WHITE	3X8	8' H x 1/2" D x 3" W
CLWAF	CLOSET WALL FILL 6 X 96	WALNU	6X8	8' H x 1/2" D x 6" W
CLWAF	CLOSET WALL FILL 6 X 96	WHITE	6X8	8' H x 1/2" D x 6" W

## HARD SURFACE PRODUCT PACKAGING DETAILS

LVT & COMPOSITE CORE	AUTHENTIC MIX	AUTHENTIC PLANK	CLASSIC STRIP	COLONIAL PLANK	EQUITY PLANK	HARBOR PLANK	HARVEST PLANK	LOOSELAY PLANK	MAJESTIC PLANK	RIGID PLUS	TIMELESS PLANK
PLANK DIMENSIONS	W: 4.889"/6.85"/8.86" L: 19.45"/39.29"/59.05"	9" x 60"	W: 3.26" L: 19.69"/39.37"/60"	6" x 48"	9" x 60"	6" x 48"	6" x 48"	6" x 48"	6" x 48"	7" x 48"	6" x 48"
CARTON DIMENSIONS	14.5" x 60" x 11"	9" x 60" x 2.75"	9" x 60" x 2.25"	6" x 48" x 1.75"	9" x 60" x 1.6"	6" x 48" x 2.75"	6" x 48" x 2.75"	6" x 48" x 2.25"	6" x 48" x 2.2"	7" x 48" x 2"	6" x 48" x 3"
PLANKS PER CARTON	8	8	22	18	6	8	16	10	12	10	11
SQ. FT. PER CARTON	16.87	29.92	21.66	36	22.44	15.76	32	20	23.64	23.64	21.67
LBS. PER CARTON	28	50	30	30	51	25	39	40	34	41	30
STANDARD PALLET SIZE	44"W x 60"L	40"W x 61.5"L	44"W x 61"L	33"W x 50"L	38"W x 61"L	40"W x 50"L	40"W x 50"L	40"W x 50"L	40"W x 50"L	40"W x 50"L	40"W x 50"L
CARTONS PER PALLET	75	60*	78	80	64	78	48	60	60	50	55
SQ. FT. PER PALLET	1,265.25	1,795.20	1,689.48	2,880	1,436.16	1,229.28	1,536	1,200	1,418.40	1,182	1,191.74
LBS. PER PALLET	2,050	3,050	2,400	2,350	3,265	1,975	1,850	2,400	2,130	2,150	1,715

	DUXXE 12 WRP	DUXXE 8 WR	ESSENCE PLANK	ADVANTAGE PLANK	LIBERTY PLANK
PLANK DIMENSIONS	7.48" x 50.67"	7.48" x 50.67"	7" x 60"	7" x 48"	7.69" x 60"
CARTON DIMENSIONS	8" x 51" x 3.75"	8" x 51" x 2.75"	7.5" x 60" x 2"	7.5" x 48" x 2.25"	8.3" x 61" x 2"
PLANKS PER CARTON	7	9	8	12	9
SQ. FT. PER CARTON	18.42	23.69	23.62	28.37	28.84
LBS. PER CARTON	39	34	49	40	40
STANDARD PALLET SIZE	33" x 51" x 3.9"	33" x 51" x 4.1"	39" x 60" x 2.9"	39" x 48" x 2.9"	4.4" x 61" x 2.9"
CARTONS PER PALLET	36	52	60	60	55
LBS. PER PALLET	1,776	1,828	3,000	2,460	2,205



## IXPE UNDERLAYMENT

- Closed cell structure will not absorb moisture or promote mildew growth as compared to other natural underlayments
- Hypoallergenic
- Comfortable under foot
- Superior sound deadening qualities
- IIC Sound rating of 62 dB
- Approved to go over radiant heat
- Can go over all types of sub floors and existing hard surface flooring

\*30 Carton pallet available



## ONLINE CUSTOMER PORTAL

### MUCH MORE THAN AN ONLINE ORDERING SYSTEM.

When you register for your own account you will be able to access the following information pertaining to YOUR account:

- Invoices
- Sales history
- Bills of lading number
- Price lists
- (on invoice)*

You will also have access to the following items:

- Warranties
- Claim forms
- Installation instructions
- Credit forms
- Marketing materials
- Tech bulletins
- Product specs
- Installation photos

### YOUR VERY OWN CUSTOMER SERVICE AVAILABLE 24/7!

Call or email to sign up:

800.272.2808 — ext 110 & ext 1108 or [info@SouthwindFloors.com](mailto:info@SouthwindFloors.com)

HARD SURFACE DISPLAYS



HSMAS - MASTER DISPLAY  
79" W x 83.5" H x 24" D



HSMAS - MASTER DISPLAY  
79" W x 83.5" H x 24" D

CARPET DISPLAYS



5-SIDED - CAROUSEL  
DISPLAY

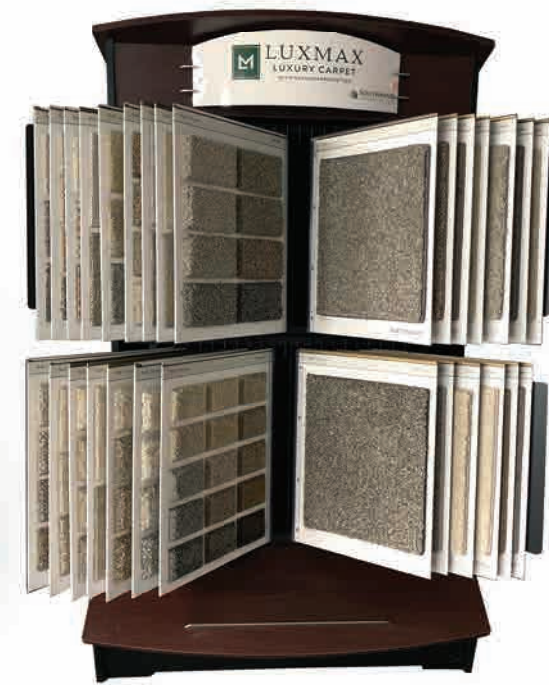

SOFT SOLUTIONS  
DISPLAY



SOFT SOLUTIONS  
DEC BOARD DISPLAY

CLOSET DISPLAYS



LLRK - LOOSE LAY  
PLANK DISPLAY  
17" W x 60" H x 16" D



6STEP - 6 SLOT  
STEP UP DISPLAY  
15" W x 44" H x 21" D



8STEP - 8 SLOT  
STEP UP DISPLAY  
15" W x 60" H x 21" D



12STEP - 12 SLOT  
STEP UP DISPLAY  
18" W x 60" H x 24" D



\*Point of Sale Unit  
84" h x 90" w x 24" d



Authentic Plank - Antique Pine

## ALISON VICTORIA'S FAVORITE FLOORING NOW AT YOUR LOCAL SOUTHWIND PROFESSIONAL DEALER.

"I LOVE XRP WATERPROOF FLOORING'S DURABILITY AND LOOKS. THAT'S WHY I HAVE THEM IN MY REMODELS AND MY OWN PERSONAL HOME."

-ALISON VICTORIA

WATERPROOF · SCRATCH-RESISTANT · EASY INSTALLATION

FIND YOUR LOCAL PROFESSIONAL DEALER AT [SOUTHWINDFLOORS.COM](http://SOUTHWINDFLOORS.COM)